



**BRASS  
MONKEY**

# **COMMERCIAL PRODUCT MANUAL**

# Contents.

## Section 1: General Information

- 4 Support & Contact Details
- 6 Purpose of the Manual
- 7 Scope of use
- 7 Safety notices and symbols used
- 11 Residual Risks

## Section 2: Getting Started

- 15 Installation Guide
- 17 General information
- 18 Sizes and weights
- 20 Finishing panels
- 24 Levelling feet
- 25 Where to earth
- 26 Where to connect the light
- 27 Connecting auto top up
- 28 Fitting dosing sensor
- 32 Priming dosing lines
- 33 Connecting to Wifi

## Section 3: Maintenance Overview

- 36 Bath Controls
- 38 Spa and Plant .3 with Auto Backwash
- 41 Pro.3

## Section 4: Daily tasks

- 44 Clearing skimmer
- 45 Clearing bottom drain
- 46 End of day wipe down
- 47 Backwash Media Filter (Spa 3 only)

## Section 5: Tasks Every 2-3 Days

- 49 Change particle filter - Pro 3 only

## Section 6: UV Bulb Change

- 52 Pro Units
- 53 Spa Units

## Section 7: Water management

- 58 Drain down and refill
- 59 Daily water testing
- 60 Check and balance water
- 62 Monthly biological testing
- 63 Cleaning the Flow Sensor

## Section 8: Understanding Hannah dosing unit

- 65 What it is / how it works
- 66 Safety measures
- 67 Chemical information
- 68 Dosing unit
- 71 Operation
- 72 Common questions
- 75 Fitting the sensor
- 77 Chemical set up
- 78 Priming dosing lines
- 79 Calibration of probe
- 86 Settings/ parameters
- 89 Password protection

## Section 9: Trouble Shooting

- 91 User Guide for Consumers
- 92 Leaks
- 92 Power
- 93 Fuses
- 94 Cloudy Water
- 94 Stuck Ice
- 95 Light Status
- 96 Auto Top Up
- 97 Low chlorine levels on opening/top ups
- 97 Dosing Lines turning brown/white/blockages
- 97 Dosing unit service lights
- 98 System Flush
- 99 Cleaning the condenser

# Section 1: General Information

## In this section...

- **Support & Contact Details**
- **Purpose of the Manual**
- **Scope of use**
- **Safety notices and symbols used**
- **Description and Specifications**
- **Residual Risks**

# Support & Contact Details

## We're in this together!

Need some help? Download the Brass Monkey app or check out our knowledge base at [brassmonkey.co/help](https://brassmonkey.co/help) to troubleshoot most issues. Here's a few tips to keep your plunge in top condition...

- **Keep on top of regular maintenance and cleaning tasks.**  
This will prevent most issues ever happening.
- **Regularly monitor the water quality throughout each day.**  
Increase the frequency if the user load is high.
- **Keep track of your daily user load.**  
We'll need to know this to help with any performance questions.
- **Shower before use.**  
You'd be amazed how much sweat, dirty feet and towel fibres impact water quality and filtration flow.
- **Keep your bath connected to wifi.**  
That way we can see how it is performing.
- **Make note of the ID number of your plunge(s).**  
It is shown beneath the QR code in the compartment area of the plunge.

## Still stuck?

Call us on +44 1135 267 255 or you can raise a support ticket on [brassmonkey.co/support](https://brassmonkey.co/support) weekdays 9:00am - 5:30pm (Fridays 4.30pm)

# Brass Monkey Commercial Range

## Model Series: Pro, Spa

These are the Original Instructions prepared by the manufacturer for the Brass Monkey Commercial Range. They contain essential safety information, installation requirements, operating instructions, and maintenance guidance necessary to ensure safe and reliable use of the equipment.

### Manufacturer Details

Manufacturer: Brass Monkey

Address: Thorp Arch Trading Estate, Unit 25 St. 6 S, Wetherby LS23 7FD

Contact: 0113 526 7255

These instructions were originally prepared in English. Any translated versions must be clearly marked “Translation of the Original Instructions” and must be accompanied by this English version.

### Intended Use

The Brass Monkey Commercial Range is designed for commercial cooling and refrigeration applications, including (but not limited to) chilled water supply, process cooling, and commercial-grade refrigeration environments.

All applications must comply with the installation, environmental, and operational limits detailed in this manual.

### Markings & Identification

All equipment identification markings, including model number, electrical ratings, and safety symbols, are repeated here for clarity.

Ensure that all nameplate details match the installation documentation before connecting the system.



## Units and Measurement

All values in these instructions are provided in metric units unless otherwise stated.

## Declaration of Conformity

This product complies with the following applicable directives and standards:

- Low Voltage Directive (LVD)
- Machinery Directive
- EMC Directive
- Relevant harmonised standards listed in the Declaration of Conformity.

A full copy of the Declaration of Conformity is available upon request.

## Noise Emissions

The A-weighted sound pressure level at the operator position for this equipment is:

- $\leq 70$  dB(A)

If the noise level exceeds required limits due to a custom element, additional noise declarations will be included with your product.

Action required: Operator should ensure that noise levels are acceptable for the intended installation environment and comply with workplace occupational noise requirements.

## Purpose of This Manual

This manual has been prepared to provide users, installers, and service technicians with the essential information required to safely install, operate, and maintain the Brass Monkey Commercial Range.

It outlines the safety precautions, technical requirements, operating procedures, and maintenance instructions necessary to ensure the equipment functions reliably, efficiently, and in full compliance with relevant regulations and standards.

Users must read and understand this manual before working with the equipment. Proper adherence to the instructions will help prevent accidents, equipment damage, and avoidable downtime.

Failure to follow the guidance provided may result in unsafe operation and may void the manufacturer's warranty.

## Scope of Use

The Brass Monkey Commercial Range is intended for commercial and industrial cooling applications, including but not limited to:

- Process cooling
- Commercial refrigeration systems
- Chilled water supply
- Temperature control in manufacturing, hospitality, and plant environments

The equipment is designed for indoor or appropriately sheltered outdoor installations, within the environmental limits and operating conditions specified in this manual.

This product must only be used for applications consistent with its design and rating. It must not be used in hazardous, explosive, corrosive, or flammable environments unless specifically approved for such use.

Any modifications, misuse, or operation outside the stated parameters may compromise safety and performance.

## General Information

### General Description of the Machinery

The Brass Monkey Commercial Range consists of high-performance commercial ice baths and chilling systems designed for continuous operation in sports, wellness, and commercial environments.

Each unit uses an R410A refrigeration circuit combined with a high-efficiency heat exchanger to provide rapid water chilling and temperature stability.

The units are supplied as air-cooled systems as standard, with water-cooled versions available upon request for specific project requirements.

The system is intended for permanent connection to mains water supply, drainage, and electrical services, and includes integrated filtration compliant with PWTAG (Pool Water Treatment Advisory Group) principles.

A top-side digital controller provides operational control, temperature adjustment, status indication, and system alerts. The unit can also be connected to a mobile application for remote operation and monitoring.

The internal PCB/control box is restricted to authorised personnel only.

## Materials to Be Handled and Their Characteristics

The system is designed to handle:

- Refrigerant: R410A (factory-sealed refrigeration circuit)
- Heat transfer fluid: Clean mains water supplied at the correct pressure
- Filtration: Integrated inline filtration system appropriate for maintaining clean circulating water in accordance with PWTAG principles (filtration quality only – *not* pool water supply)
- Airflow: Ambient air drawn through the condenser on standard air-cooled models

Water Supply Requirements:

- Mains water only
- Minimum inlet pressure: 1.0 bar
- Maximum inlet pressure: 2.0 bar
- A pressure regulating valve (PRV) must be installed if pressure exceeds 2 bar
- A shock arrestor must be installed to protect the system from pressure fluctuations
- No connection to pool water or chemical dosing systems is permitted

Use of untreated, contaminated, or chemically altered water will affect equipment performance and may void warranty.

## Operator Positions and Operating Conditions

Operator interaction with the unit is limited to safe access points including:

- Top-side controller (primary user interface)
- Filtration system access (routine checks and maintenance)
- Water inlet/outlet isolation valves
- Electrical isolation point (for authorised personnel only)
- Mobile app interface for remote monitoring and control

Operators must not access internal components, including the PCB box, unless trained and authorised.

Normal operator activities include:

- Starting, stopping, and adjusting the system via the controller
- Monitoring system temperatures, alerts, and status indicators
- Managing filtration and water quality in accordance with PWTAG guidance
- Responding to warnings or shutdown conditions (e.g., low flow, overheat)
- Conducting visual checks for airflow obstructions or leaks.

## Environmental Operating Conditions

The Brass Monkey Commercial Range must be operated within the following environmental parameters:

- Ambient air temperature: 5°C to 35°C
  - Optimal performance: 5°C to 28°C
  - At 35°C, the system may enter over-temperature protection mode, temporarily shutting down to protect the compressor.
- Installation environment:
  - Indoor plant areas or poolside settings
  - Outdoor installations permitted if adequate ventilation and weather protection are provided
- Humidity: Suitable for poolside environments; components selected for resistance to elevated humidity typically found in such settings
- Ventilation: Sufficient free airflow must be provided around the condenser and service panels
- Water supply: Permanent potable supply or compliant pool water supply
- Drainage: Permanent and accessible connection for backwash, overflow, or drainage where applicable
- Power: Must be connected by a qualified electrician to a suitable supply; Wi-Fi connection is required to maintain full warranty and enable remote support.

## Safety Functions Overview and Locations

The system includes multiple protective devices and safety functions to ensure reliable and safe operation:

### Integrated System Protections

- Over-heat protection: Protects compressor and system components during high ambient operation
- Frost protection: Prevents freezing within the heat exchanger
- Low-flow alert: Indicates insufficient flow through the system
- No-flow shutdown: Prevents compressor operation without adequate water circulation
- Inbuilt RCD: Provides electrical protection against ground faults.
- Skimmer Cover: Covers suction point at top of bath. Bath not to be used without this in place

## Connectivity and Monitoring Safety

- Wi-Fi connectivity:
  - Required for warranty
  - Enables remote diagnostics and system monitoring
  - Provides alerts for flow issues, temperature faults, or shutdowns

## Mechanical and Electrical Safety

- Authorised-access PCB box: Prevents untrained personnel from accessing live or sensitive components
- Qualified installer requirement: Electrical, drainage, and water connections must be completed by competent professionals
- Filtration compliance: Inline filtration supports PWTAG-aligned safe water quality, reducing hygiene risks

The exact location of safety sensors and protection devices is provided in the system's technical schematic.

## Residual Risks

Despite the inherent safety design measures, protective controls, and operational instructions provided with the Brass Monkey Commercial Range, certain residual risks remain during normal use of an ice bath. These risks cannot be fully eliminated without compromising the intended function of the equipment. Users and operators must therefore be aware of the following:

### Physiological Risks to Bathers

Cold-water immersion carries inherent physiological risks, even when equipment is functioning correctly. These include:

- Cold shock response, such as rapid breathing, gasping, increased heart rate, and panic sensations.
- Hypothermia risk, especially with prolonged exposure or temperatures below 10°C.
- Reduced mobility or numbness, which may impair a user's ability to safely exit the bath.
- Dizziness or light-headedness on entry or exit due to sudden temperature change.

Users must follow exposure guidelines as stated in the user poster and avoid extended or unsupervised immersion.

### Medical Condition Risks

Certain individuals may face elevated risks when using cold-water immersion equipment, including but not limited to:

- People with heart conditions, high blood pressure, or cardiovascular disease
- Individuals with respiratory conditions, including asthma
- Pregnant individuals
- Users with circulatory issues, diabetes, neuropathy, or reduced thermal sensation
- Individuals taking medications that affect heart rate, blood pressure, or circulation

Users belonging to these groups may only use the equipment after obtaining medical advice. These warnings are clearly displayed in the supplied User Guide poster.

## **Behavioural and Usage Risks**

The following behaviours may increase the risk of injury:

- Entering the ice bath too quickly or when excessively cold
- Remaining submerged for longer than recommended
- Using the equipment alone or without supervision
- Consuming alcohol, recreational drugs, or certain medications before use
- Forcing oneself to stay in the water despite strong discomfort or signs of distress

Such behaviours cannot be controlled by the equipment and rely on responsible user judgement.

## **Slips, Trips, and Falls**

Wet surfaces associated with ice bath use may cause:

- Slippery flooring around the installation area
- Difficulty maintaining footing while entering or exiting the bath
- Increased fall risk due to cold-related stiffness or numbness

Operators must ensure that anti-slip matting, adequate drainage, and safe access/egress are provided. Users must take care when entering and exiting the unit.

## **Water Quality and Filtration Risks**

Although the system includes filtration meeting PWTAG-aligned guidance, the following residual risks remain:

- Inadequate filtration management may lead to poor water hygiene
- Failure to follow cleaning and sanitation instructions may result in bacterial growth
- Low-flow or no-flow conditions may cause system shutdown, affecting water turnover

Operators are responsible for maintaining the filtration system as instructed in the manual.

## **Residual Equipment Risks**

The design includes multiple safety features, yet the following residual hazards remain due to the nature of refrigeration and water systems:

- Surfaces may become cold and cause temporary skin sensitivity
- System shutdown due to over-temperature protection can interrupt operation
- Electrical isolation is required before maintenance
- Water pressure fluctuations may cause operational disruptions if supply pressure is not correctly regulated

Only authorised personnel may access the PCB box and internal components.

## **User Awareness**

The User Guide Poster supplied with the product forms part of the mandatory safety information and must be displayed in a visible location where the ice bath is installed. It provides users with:

- Exposure recommendations
- Safe-use instructions
- Pre- and post-immersion guidance
- Health warnings and contraindications

Operators must ensure that all users read, understand, and follow the guidance before using the ice bath.

# Section 2: Getting Started

## In this section...

- **Installation Guide**
- **General Information**
- **Sizes and Weights**
- **Finishing Panels**
- **Levelling Feet**

# Installation Guide

## Initial Set Up Overview

Setting up your Brass Monkey bath correctly is essential for safe operation, reliable performance, and long-term durability. This overview provides a high-level summary of the setup process, with references to the relevant sections of this guide for full details.

Please review section 2 Living with your Ice Bath to understand the access requirements to your bath for one off maintenance tasks.

### Step 1: Prepare the Installation Space

- Ensure the floor is level and can support the full weight of the filled unit (see Section 1 – General Information).
- Make sure the route to the final installation location is clear and wide enough to move the bath into place.
- If you need to remove any panels to help move the bath, refer to Section 2 – Installing / Removing External Panels.

### Step 2: Position the Bath and Level It

- Carefully move the bath into place using appropriate lifting equipment and PPE.
- Never lift from the top deck – always lift from the steel frame.
- Use the adjustable feet to ensure the bath is level (see Section 2 – Installing / Removing External Panels).
- For standalone units it is essential there is **30cm around the bath for ventilation**.

### Step 3: Connect Services

- Have a qualified plumber and electrician connect:
  - Power supply
  - Water inlet
  - Drainage
- Refer to Section 3 – Connecting to Services for guidance on all utilities.

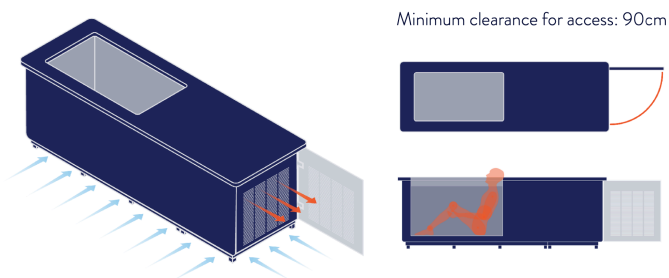

It's important to give your Brass Monkey space to breathe.  
Please ensure there is **30cm minimum** around the unit for airflow.

#### **Step 4: Fit the Auto Top-Up (if applicable)**

- Only connect the Auto Top-Up if the bath is plumbed to a fresh water mains supply.
- Instructions are in Section 4 – Connecting the Auto Top-Up System.

#### **Step 5: Set Up the Hanna Doser and Chemicals**

- Fit the sensor probe into the pipework (see Section 5 – Setting Up the Hanna Doser).
- Label and connect the chemical bottles according to the guide.
- Prime the dosing lines only once the unit is switched on and fully set up.

#### **Step 6: Final Checks Before Use**

- Check all panels are securely refitted.
- Confirm all services are connected and leak-free.
- Power on the unit and verify the system is operational. Power on by pressing the orange button on the RCD.
- Refer to you product specific flash cards for operation guidance

# General Information

## The Ice Bath

1. Top Surface
2. Stainless Steel Tub
3. Adjustable Feet
4. Access Door
5. Ventilation (Outlet)
6. Ventilation (Inlet) - 30cm space required around the bath for ventilation

Ensure the installation location is level and strong enough to support the weight of the fully filled bath.

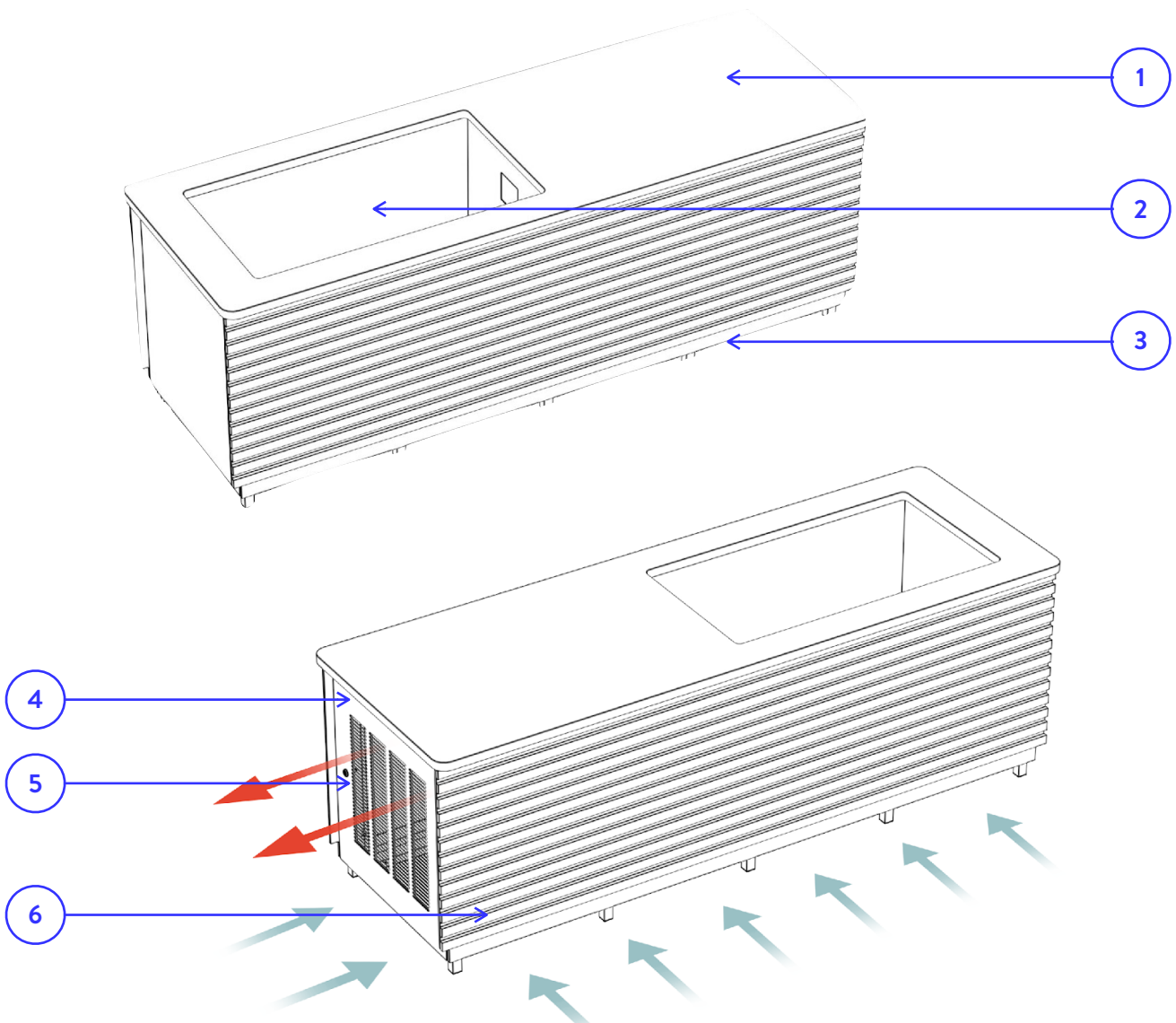

# Sizes & Weights

## Cladded

| Model          | Length (cm) | Width (cm) | Height (cm) | Weight (kg) | Volume (L) |
|----------------|-------------|------------|-------------|-------------|------------|
| Pro            | 206         | 81         | 88          | 280         | 410        |
| Pro Plant      | 162         | 81         | 88          | 299         | 410        |
| Spa Corner     | 265         | 199        | 94          | 606         | 440        |
| Spa Island     | 199         | 155        | 94          | 597         | 440        |
| Spa Duo        | 199         | 207        | 94          | 638         | 860        |
| Spa Social     | 265         | 384        | 94          | 1165        | 2 x 440    |
| Step (Pro)     | 86          | 56         | 27          | 10          | N/A        |
| Step (Spa)     | 59          | 59         | 21          | 13          | N/A        |
| Galley Plunge  | 193         | 91         | 94          | 320         | 440        |
| Compact Plunge | 85          | 199        | 94          | 260         | 440        |
| Duo            | 193         | 143        | 94          | 350         | 860        |

# Sizes & Weights

## Un-Cladded

| Model          | Length (cm) | Width (cm) | Height (cm) | Weight (kg) | Volume (L) |
|----------------|-------------|------------|-------------|-------------|------------|
| Pro            | 195         | 76         | 78          | 190         | 420        |
| Pro Plant      | 152         | 76         | 85          | 200         | 410        |
| Spa Corner     | 253         | 186        | 90          | 500         | 440        |
| Spa Island     | 186         | 145        | 90          | 497         | 440        |
| Spa Duo        | 186         | 197        | 90          | 538         | 860        |
| Spa Social     | 253         | 372        | 90          | 965         | 2 x 440    |
| Step (Pro)     | 76          | 49         | 20          | 7           | N/A        |
| Step (Spa)     | 52          | 52         | 17          | 10          | N/A        |
| Galley Plunge  | 186         | 78         | 90          | 90          | 440        |
| Compact Plunge | 78          | 186        | 90          | 90          | 440        |
| Duo            | 186         | 130        | 90          | 260         | 860        |

# Finishing Panels

## The Bath Panels

Before positioning the bath ensure your route is clear, and you have the correct equipment, and remove all packaging.

To get the bath into place you may need to remove panels.

Panel removal may also be required for occasional maintenance that isn't part of every day servicing.

### Types of fixings

1. Button Fixes & Panel Hooks
2. Panel Brackets
3. Hinges.

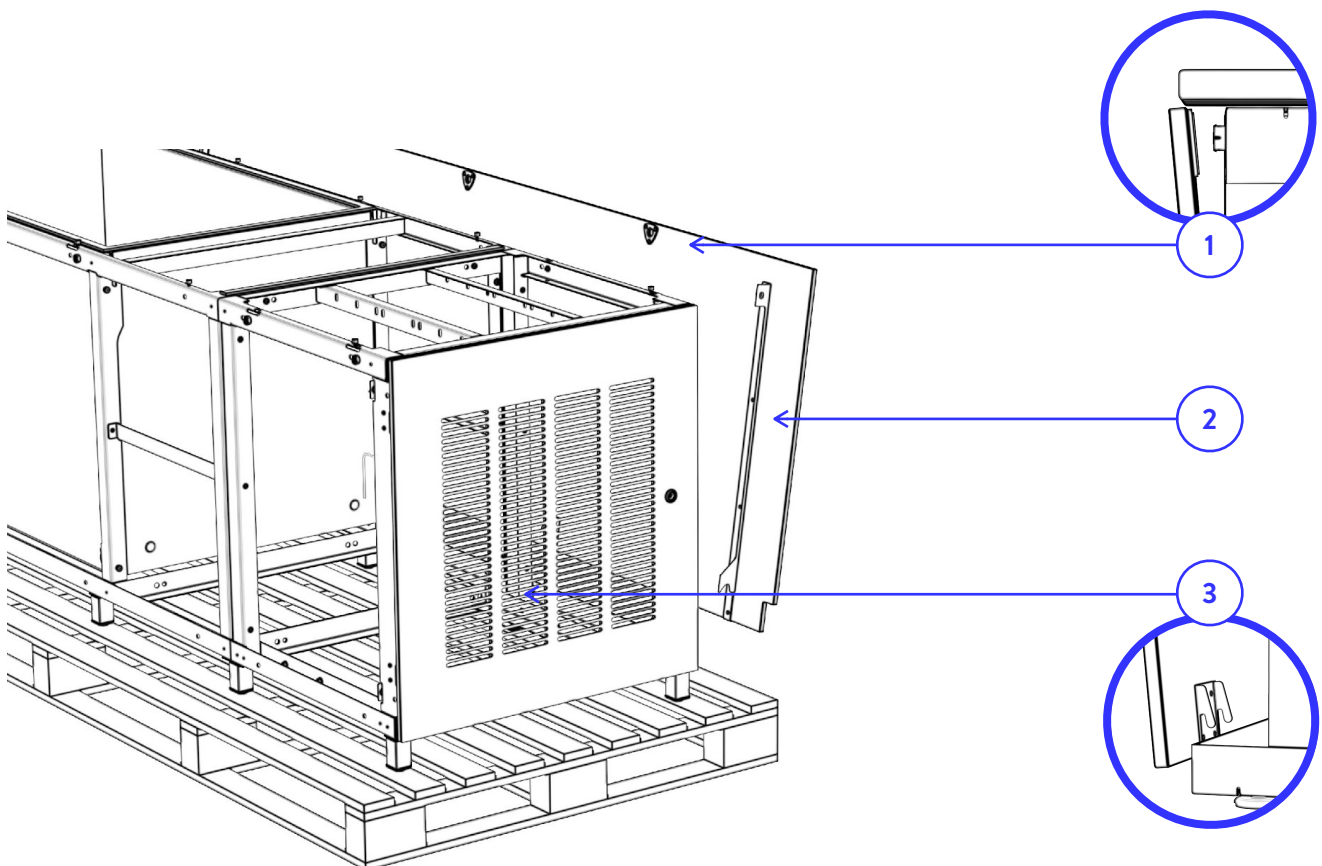

## Buttons Fixes & Panel Hooks

### Where to find them

- Spa - Plant Side Panels, Infill Panel, Bath end panels
- Pro - Bath end panel

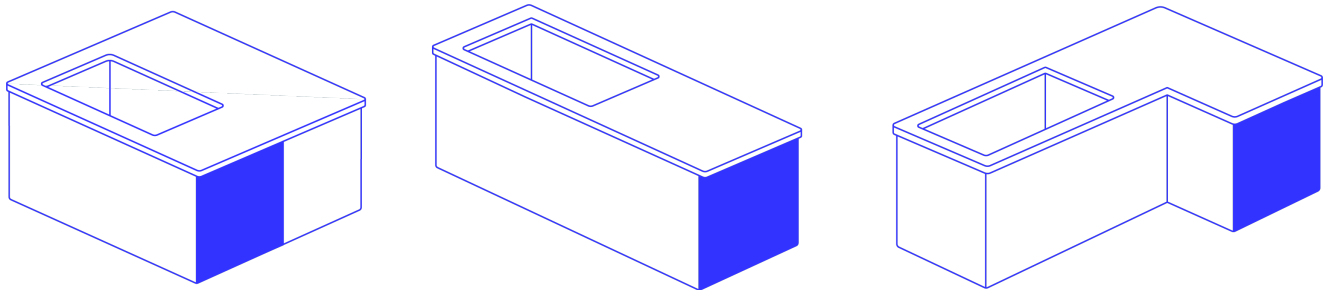

### How to remove the panel

- This panel may be fitted with a lock.
- If there's a lock: Unlock it, then lean the panel towards you (away from the bath) and lift it up off the panel hooks.

### To re-fit the panel:

- Line up the hooks on the panel with the bath frame and hang it in place.
- Then push firmly to click it back onto the button-fix mounts — this will require a hard push to engage fully.

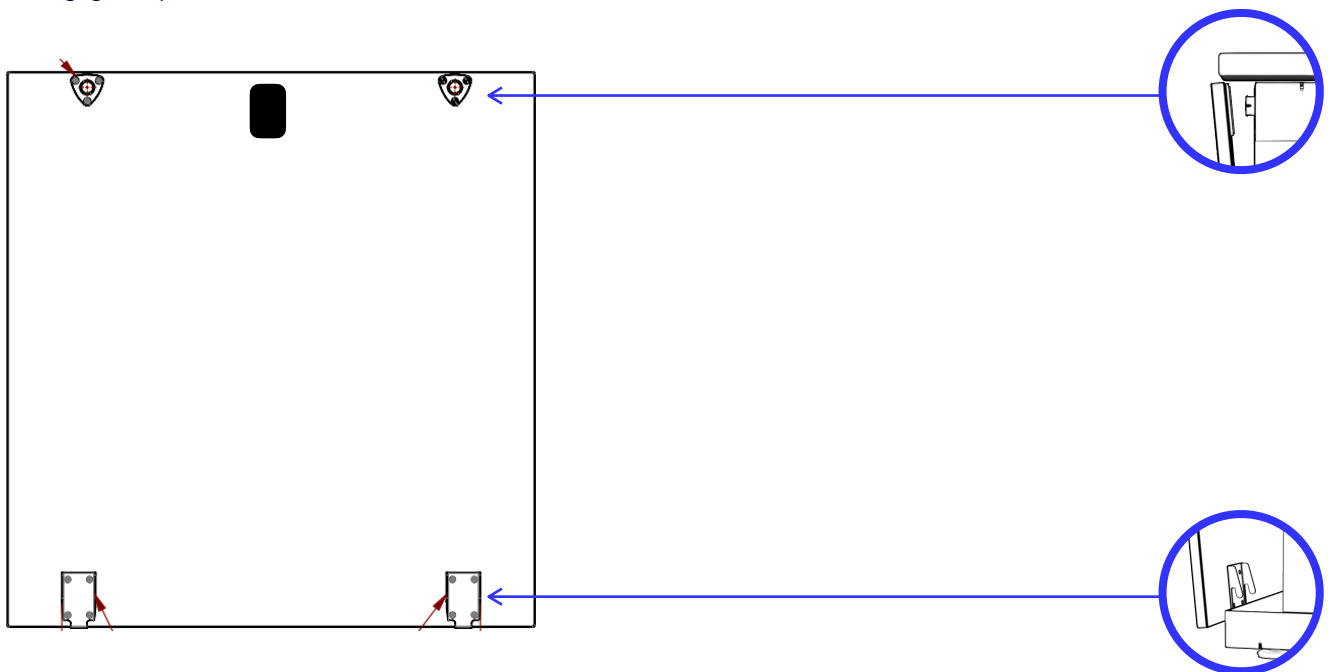

## Panel Brackets

### Where to find them

- Spa - Bath Side panels
- Pro - Front & Back panel

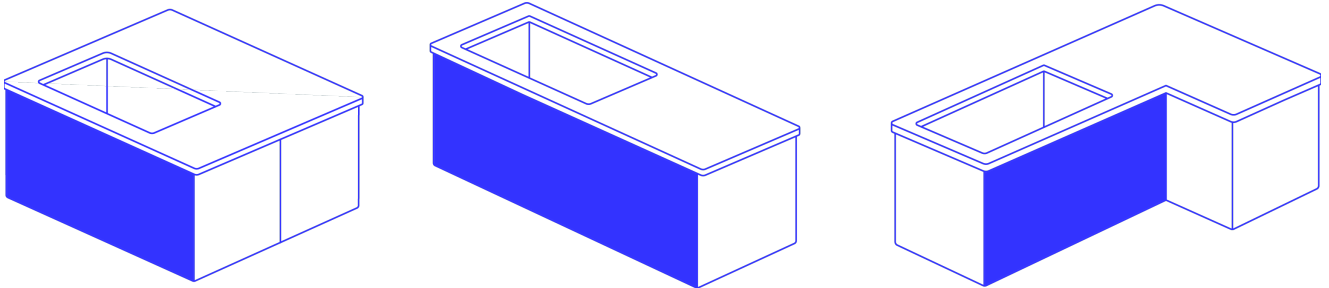

### You will need:

- An M8 spanner or socket
- At least 2 people

### How to remove the panel:

- The bath end panel will need to be removed to access the panel bracket fixings.
- At each end of the bath, locate the M8 bolts securing the panel bracket to the bath frame.
- Using an M8 spanner or socket, remove one bolt at each end. The panel will remain held in place by the button-fix mounts.
- Once both bolts are removed, pull the panel off the button-fix mounts, lean it forward (away from the bath), and lift it up off the frame hooks.

### To re-fit the panel:

- Line up the hooks on the panel with the bath frame and hang it in place.
- Push firmly to click it back onto the button-fix mounts — this will require a solid push.
- Re-fit the M8 bolts at each end to fully secure the panel.

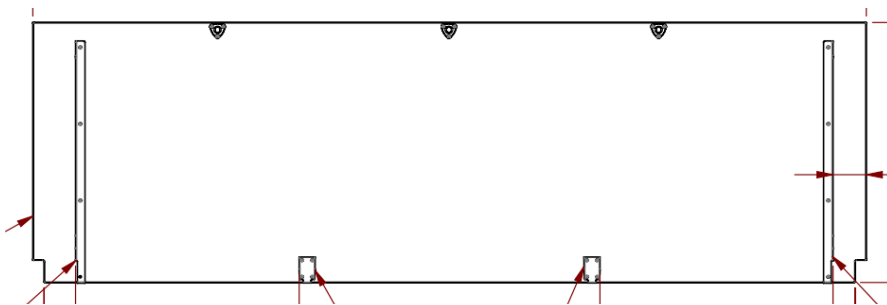

### Note:

This panel uses hooks to hang on the bath frame, button fixes along the top, and tall brackets for secure attachment.

# Top Deck Fittings

## Where to find them

- Spa - Top deck is made of two joining pieces
- Pro - One top deck

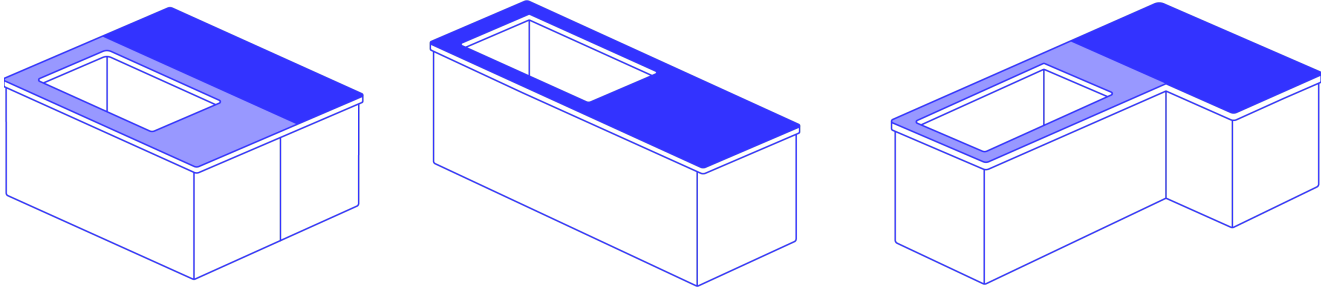

## You will need:

- An M8 spanner or socket
- At least 2 people

## How to remove the top deck:

- Remove the panels first – the top deck cannot be removed with them in place.
- Using a PH3 screwdriver, look underneath the top edge of the bath frame.
- You'll see fixings running around the perimeter of the bath and plant section.
- Unscrew each fixing carefully and set them aside safely.

 Do not pull them out – this could dislodge the squirrel fixings inside the top deck.

 We seal the top deck with a bead of silicone to prevent water ingress, this may require cutting to remove the top deck and then reapplying.

## To re-fit the top deck:

- Place the top deck onto the frame.
- Align the squirrel fixings with the holes in the frame.
- Once aligned, use the PH3 screwdriver to refit the screws through each hole.

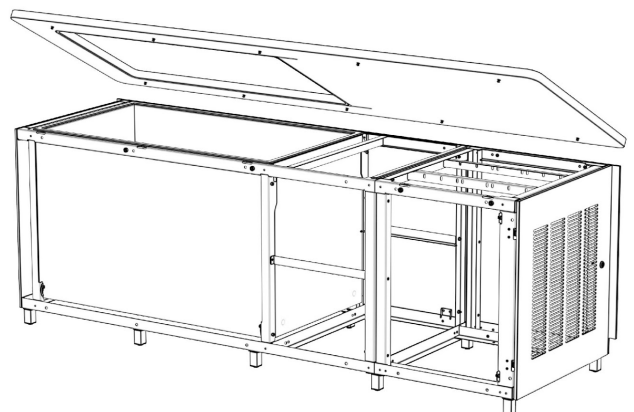

# Levelling Feet

## You will need:

- Slim 30mm Spanner / Adjustable Spanner
- At least 2 people

 The ice bath should be positioned on a flat level surface suitable for holding the weight of the bath once filled. Levelling the feet should be a last resort.

## How level the feet:

- Use the spanner to unwind the fitting at the bottom of the foot as shown in diagram.
- Please note that the unit may require lifting in order to level the feet. If lifting the unit you must ensure you have the right number of people, lifting equipment and PPE.

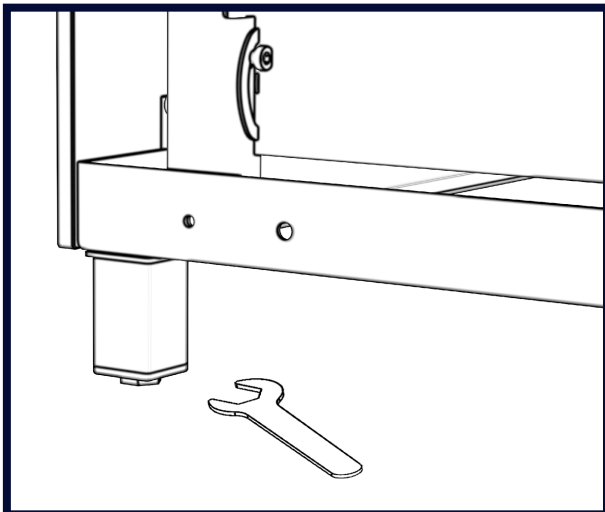

# Where to earth

 This is applicable to plant room set ups where the plant and bath are separated and should be completed by a Brass Monkey engineer or an electrician.

## Earth Connections

- There is a total of 3x earth connections
  - Plant cube frame to PCB Board - This will already be in place by Brass Monkey
  - UV Light to PCB Board or Frame - This will already be in place by Brass Monkey
  - Bath to PCB Board or Frame - This will need to be completed by the customer/contractor completing the installation

## Connecting Bath Earth Wire

- The earth wire will be coiled up at the bath compartment area, uncoil and take to the PCB box within the plant.
- Ensuring that the power has not been connected to the ice bath open the PCB control box
- Strip the earth wire (green/yellow) so about 10mm of bare copper is exposed
- Lift one of the orange leaves on the connector fully up
- Insert the bare copper of the earth wire fully into the open hole
- Push the orange level back down until it clicks shut
- Check the wire is secure and does not pull out
- Close the PCB Box up when completed

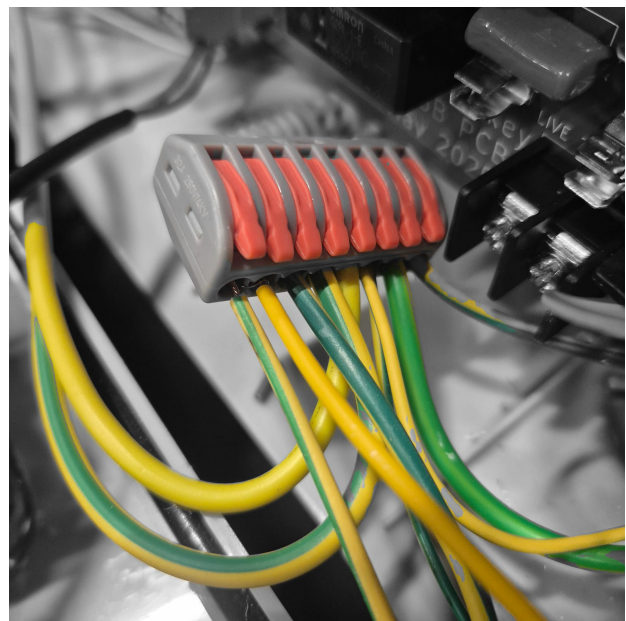

# Where to connect the light

 This is applicable to un-cladded ice baths or where the top deck requires installing on site

## Connecting to the power supply

If the bath is supplied un-cladded the bath light will be included in your welcome kit and the power supply will already be in place, ready for connection. If a top deck is being supplied with your bath then the light will be pre installed to the top deck.

The power supply for the bath light will exit the PCB box through the highlighted grommet and will be pre-fitted with a 2 way connector.

To connect the bath light cable to this connector, follow the steps below:

## Connecting the light cable to the connector

- Unscrew the Cap
  - Unscrew the outer black cap on the free end of the connector (the ribbed section)
- Slide the parts onto the cable
  - Life the cap and the rubber seal onto the light cable first, in the same order they were removed (cap first, then seal)
- Feed the cable through the connector body
  - Push the cable through the main body of the connector until the inner cores are fully through
- Make the electrical connections
  - Strip the cable insulation as required and connect the wires to the internal terminals ensuring the correct colour to terminal matching
- Seat the seal
  - Ensure the rubber seal is positioned neatly around the cable and seated correctly inside the connector body
- Tighten the cap
  - Sure the cap back onto the connector body and tighten firmly by hand. This compresses the seal and provided a watertight connection
- Final check
  - Check the cable to ensure is is secure and the cap is fully tightened

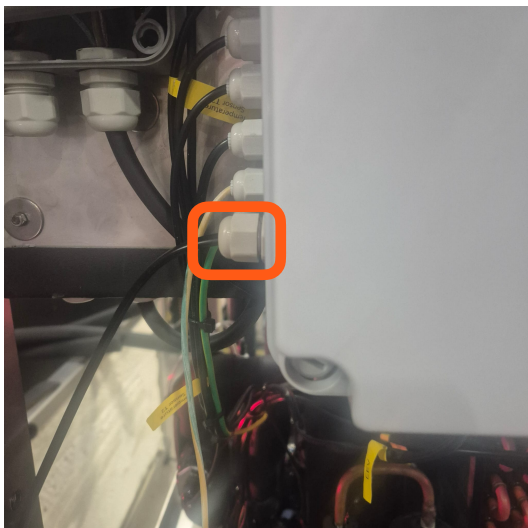

# Connecting Auto Top-Up

Auto Top Up should only be connected if the bath is connected to fresh water.

If the bath is not connecting to mains water then auto top should be left disconnected. This connector is located near the fill valve within the plant of your bath.

## To Connect the Waterproof Plug and Socket:

- Check for Alignment
  - Examine both the male (pin) and female (socket) ends.
  - Align the notches and guide marks on each connector (usually located on the black ring near the pins).
- Insert the Connector
  - Gently push the male plug into the female socket.
  - Do not force it—if resistance is felt, double-check the alignment.
- Screw Tight the Blue Locking Ring
  - Once connected, rotate the blue threaded ring clockwise to lock both connectors together.
  - Tighten until snug. This ensures a watertight seal.
- Secure the Dust Cap (Optional)
  - If not in use, place the protective dust cap over the exposed end to protect from dirt and moisture.

## Maintenance Tips

- Inspect seals and threads regularly for dirt, wear, or damage.
- Avoid over-tightening the locking ring to prevent cracking.
- Always use waterproof-grade cable suitable for outdoor use with these connectors.

## To Disconnect the Connector:

- Power Off First
  - Ensure the circuit is completely powered down.
- Unscrew the Blue Locking Ring
  - Rotate the blue ring counterclockwise to release the locking mechanism.
- Gently Pull Apart
  - Pull the male and female ends apart while holding the black bodies of the connectors.
  - Do not pull by the wires.
- Use Dust Caps
  - Place the cap over the exposed connector to maintain waterproofing and prevent damage.



# The Hanna Doser

Below is an illustrated reference of a generic, in-line installation scheme with the relevant components.

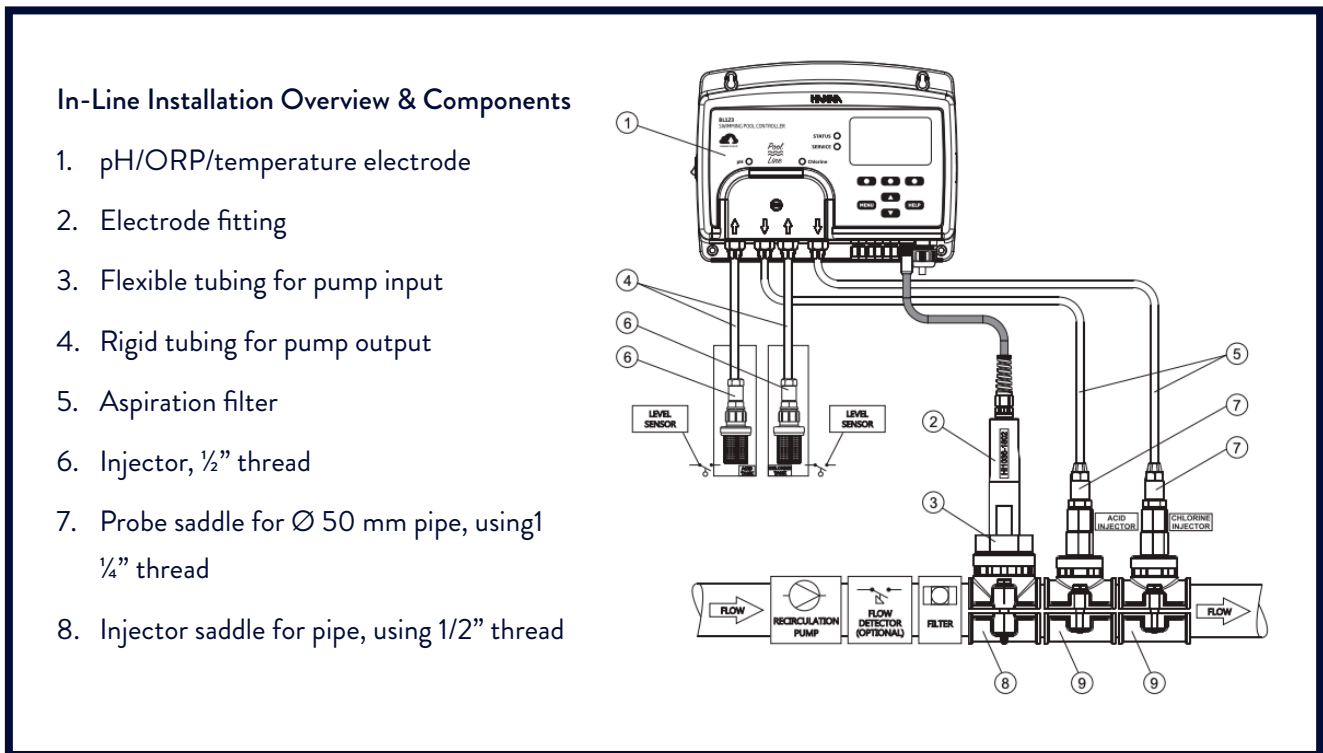

## Chemicals Specifications

- Chlorine: Sodium Hypochlorite (available in 11–12% or 14–15%).
- pH Control: Sulphuric Acid (no more than 16% strength)

Both of which can be supplied by Brass Monkey (within the UK)

## Storage

Store in a cool, dry place, away from sunlight and heat.

Keep it in its original container (HDPE or polyethylene) and ensure it's tightly sealed.

## PPE

Gloves: Wear chemical-resistant gloves (nitrile or rubber).

Eye Protection: Use safety goggles or a face shield.

Clothing: Wear an apron or protective clothing to prevent splashes.

Ventilation: Ensure the area is well-ventilated, or wear a mask if fumes are present.

# The Hanna Doser

## Fitting the sensor

The Hanna dosing unit is installed into all commercial units from March 2025 as standard.

Due to transportation we do not install the sensor into the pipework, instead it is fitted with a protective cap which requires removing before being inserted into the pipework.

**Before the bath is filled and before you have switched the power on...**

1. Locate the injector lines, near these will be a screw cap. Unscrew this as this is where the sensor probe will be secured.

 **Keep the cap** - You will need this in the future when you need to remove the probe for calibration. Keep it safe.



Typical Spa Set Up

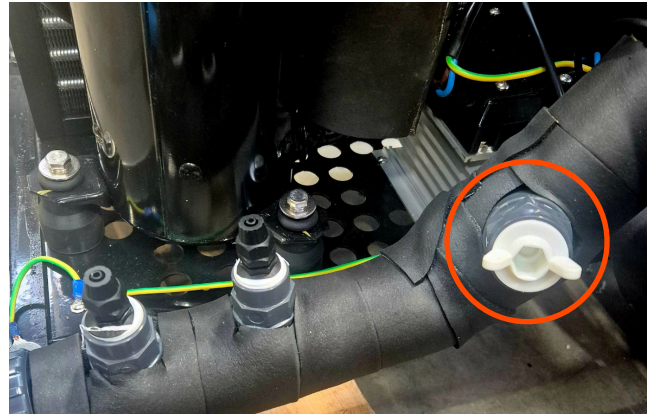

Typical Pro Set Up

2. Remove the protective cap from the sensor.
3. Ensure the O ring stays in place on the sensor
4. Insert the sensor probe and screw carefully into the saddle.

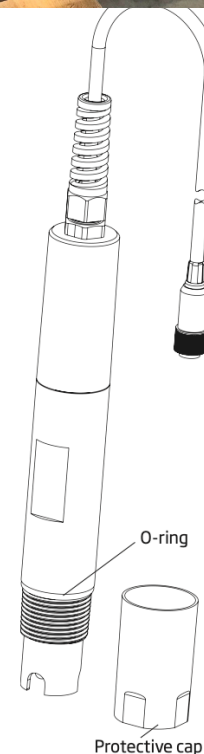

# The Hanna Doser

## Chemical Set Up

The dosing unit contains two pumps: one labelled pH and one labelled Chlorine.

- Each pump has two lines:
  - Injection line – this line runs from the dosing unit into the pipework and is pre-installed by Brass Monkey.
  - Suction line – this line draws chemical from the bottle and is pre-fitted to the bottle lid and aspiration filter.



Injection Points

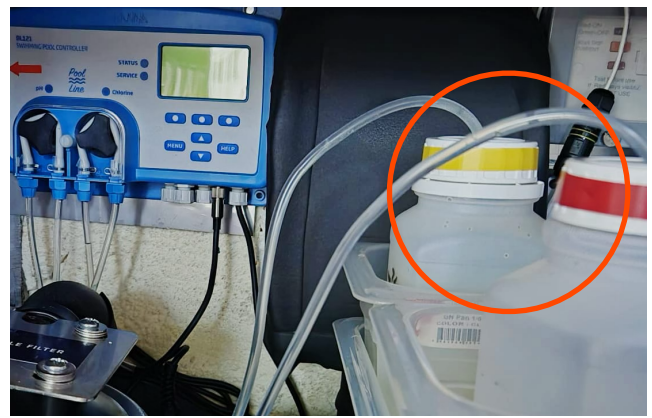

Suction lines

**You will receive a total of four bottles:**

- 2 with Yellow markings – for Chlorine
- 2 with Red markings – for Acid (pH)

## Labelling

As the operator, you must clearly label each bottle with the name of the chemical it will contain.

# The Hanna Doser

## Chemical Set Up (continued)

There are two types of bottle lids provided:

- Perforated lids (with holes):
  - Fitted with injection lines and aspiration filters
  - These lids stay inside the unit at all times
  - One Yellow and one Red bottle will use these lids
- Solid lids (no holes):
  - Used for safely transporting chemicals
  - One Yellow and one Red bottle will use these lids
  - Fill these bottles in your designated safe area
  - Once filled and sealed, transport them to the bath
  - At the bath, swap the solid lid for the perforated lid (which remains with the dosing system)

### Connecting the Dosing Lines

Before connecting any lines, trace each line back from the dosing unit to identify its purpose:

- The pH line must be connected to the Red (Acid/pH) bottle
- The Chlorine line must be connected to the Yellow (Chlorine) bottle



It is critical that each dosing line is connected to the correct chemical to ensure safe and accurate operation of the system.

# The Hanna Doser

## Priming The Dosing Lines

Priming the dosing lines helps pull chemical from the bottles quickly through the lines to the dosing point, rather than waiting for normal operation to do so.

### Important:

- Priming can only be done once the full setup is complete and the bath is switched on.
- If the bath is in maintenance mode, the Hanna dosing unit will remain off—even if the switch on the unit is in the ON position.

### How to prime the lines:

- Press the Menu button on the dosing unit.
- Scroll to the correct pump:
  - Select C12 Pump for Chlorine
  - Select Acid for pH
- Press the left circle button under “On 10s”.
- A 10-second countdown will begin.
- Watch the suction line connected to the Chlorine or Acid bottle.
  - This step confirms that the correct chemical is connected to the correct line:
    - Acid → Acid line (Red)
    - Chlorine → Chlorine line (Yellow)
- You can keep pressing “On 10s” to extend the run time in 10-second intervals.
  - Keep watching the chemical rise through the suction line.
  - When the chemical reaches the dosing unit, press Off on the pump.
- Repeat this process for both lines – Acid and Chlorine.
- Before completing ensure both pumps are switched back to AUTO

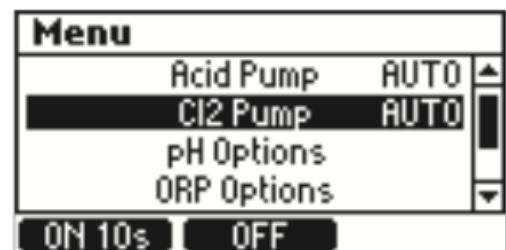
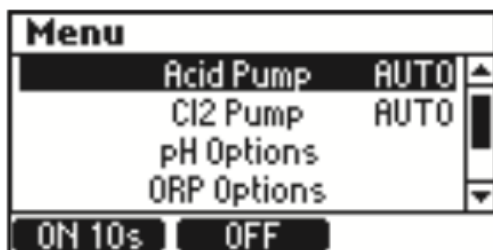

# Connecting to the WiFi

To ensure your Brass Monkey bath runs exactly as it should, our Support Team requires the unit to be connected to WiFi. This connection allows us to monitor performance remotely and support you more effectively.

Once your bath is connected, we can provide you with an Observer Link that lets you view key data such as Cooling efficiency, flow rates and maintenance logs

 **Important:** To keep your unit within warranty, your bath must remain connected to WiFi.

## Getting Set Up

- Check your WiFi:
  - Make sure the signal reaches your bath location
  - The network must be 2.4 GHz (this info is usually printed on the back of your router)
  - If the signal isn't strong enough, consider moving the bath closer to the router or installing a WiFi booster
- Download the App:
  - Search for Brass Monkey in your app store and download it
  - Open the app and create your account
  - Scan the QR code located on the control box of your bath
- Follow the App Setup:
  - Answer the setup questions
  - Go to Bath Settings
  - Enter your WiFi name and password to connect your bath to the cloud



## Remote Control

Once connected, you can adjust the bath temperature from your phone.

Please note: temperature changes are sent to the cloud first, then passed to the bath — it may take a minute or two to reflect on the unit.

## Gym Operators

If members of your team download the app and link it to the unit, they will have the ability to control the bath remotely. Please manage access accordingly.

For all other maintenance tasks please follow your product specific flash cards that can be downloaded from [brassmonkey.co/help](https://brassmonkey.co/help) or contact our support team for further assistance [brassmonkey.co/support](https://brassmonkey.co/support)

# Section 3: Maintenance Overview

In this section...

- Bath Controls
- Spa and Plant .3 with Auto Backwash
- Pro.3

# Important Notice

## Before Powering on the Ice Bath

- Ensure the ice bath is **completely filled with water** before switching on the chiller
- All electrical connections must be **installed and certified** by a qualified electrician
- All plumbing connections must be properly **fitted and pressure-tested** by a competent plumber
- Do not operate the unit if any **leaks, damage, or loose cables** are present
- Keep the Residual Current Device (RCD) accessible and **test it before first use**.

**Failure to follow these steps may result in equipment damage or serious safety risks.**

## Onboard RCD

- Press the orange button to power on
- Press the red button to switch off.

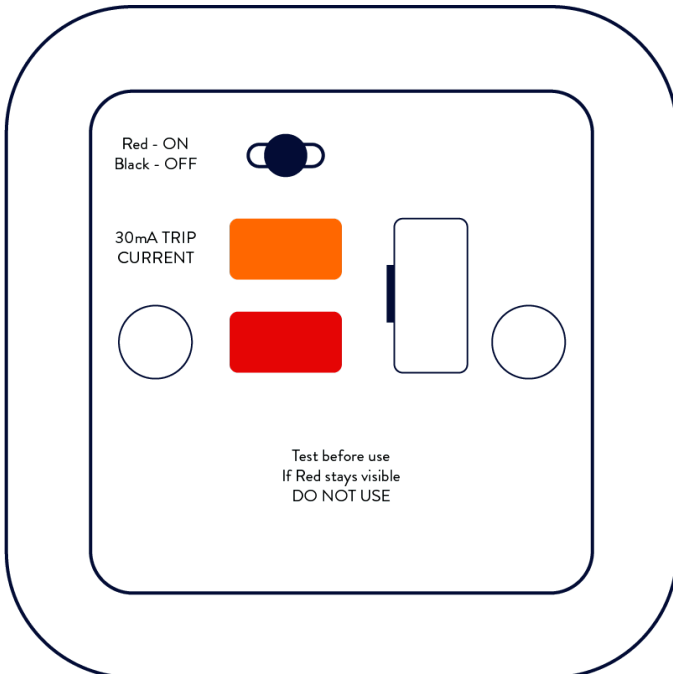

# Bath Controls

## The Control Panel SPA

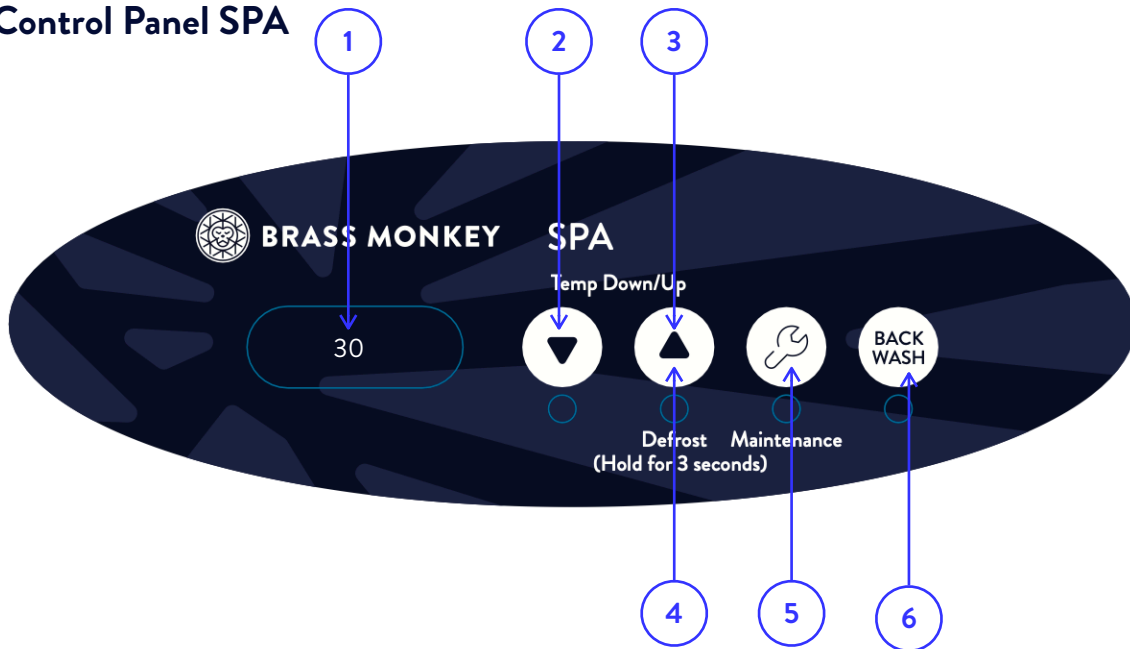

### 1. Temperature Display

The control panel displays the CURRENT water temperature. The display has no decimal place, therefore 3°C is displayed as 30. When up or down keys are pressed, the TARGET temperature is displayed.

### 2. Temp down

The lowest temp setting is 3°C for chill products. For Ice products the target temp dial goes down to 2°C, then under 2°C there are 3 levels of ice intensity to choose from (1-3). Level 3 is the most intense.

Please note, when changing the target temperature, the cooling engine may take a few minutes to restart.

### 3. Temp up

The highest temperature setting is 10°C, going above this sets the bath to 'idle' (filtration continues to run but the cooling engine is off). NB. If the target temp is adjusted to be set above the current water temp, there is no heating function - water will warm up naturally until the target set exceeded, when cooling will kick back in.

### 4. Defrost

This function is for ice baths only, and should only be used if ice ever becomes stuck on the sides of the plunge.

### 5. Maintenance mode (spanner)

Press and hold for 3 seconds to put the bath into a maintenance mode - The LED light on the chiller and light in the bath will flash 3 seconds on 3 seconds off whilst in this mode. From here you can change the particle filter. Exit maintenance mode by pressing and holding for 3 seconds again. **\*Note under normal operating tasks, maintenance mode is not required\***

### 6. Backwash Mode

Press and hold for 3 seconds to activate a backwash. The backwash will be completed and once finished the bath will go back to normal operation. **\*Backwashing on Auto Backwash systems is completed via the media filter screen\***

### Bath light

The light in the bath will remain on even when not in use. The light will flash when in maintenance/backwash mode. If the light flashes when not in one of these modes contact the support team.

# Bath Controls

## The Control Panel PRO

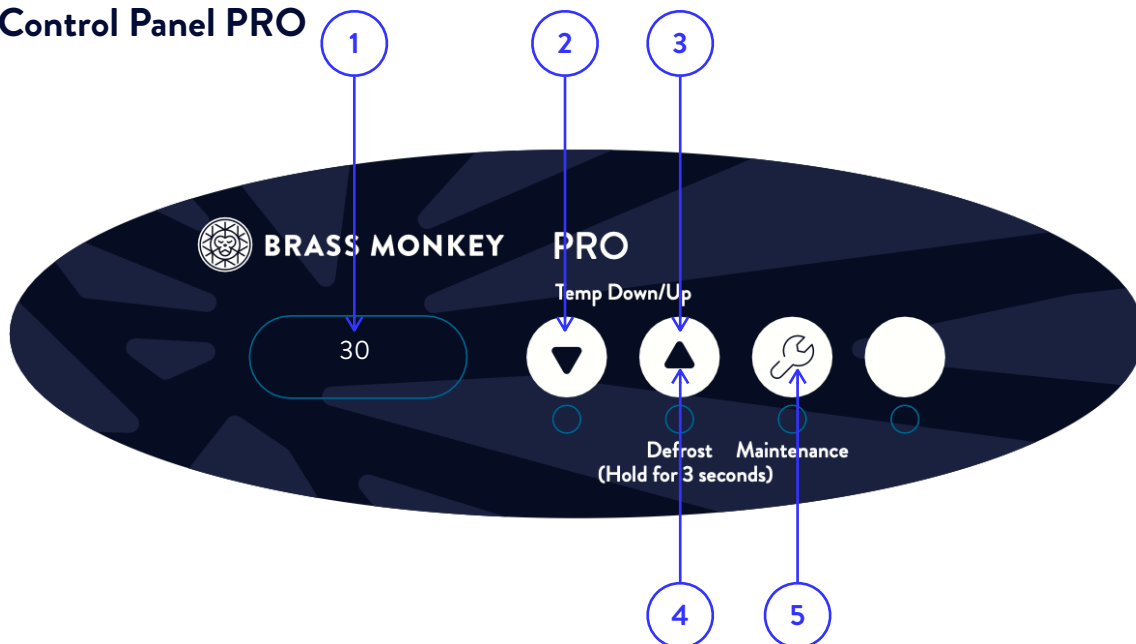

### 1. Temperature Display

The control panel displays the CURRENT water temperature. The display has no decimal place, therefore 3°C is displayed as 30. When up or down keys are pressed, the TARGET temperature is displayed.

### 2. Temp down

The lowest temp setting is 3°C for chill products. For Ice products the target temp dial goes down to 2°C, then under 2°C there are 3 levels of ice intensity to choose from (1-3). Level 3 is the most intense.

Please note, when changing the target temperature, the cooling engine may take a few minutes to restart.

### 3. Temp up

The highest temperature setting is 10°C, going above this sets the bath to 'idle' (filtration continues to run but the cooling engine is off). NB. If the target temp is adjusted to be set above the current water temp, there is no heating function - water will warm up naturally until the target set exceeded, when cooling will kick back in.

### 4. Defrost

This function is for ice baths only, and should only be used if ice ever becomes stuck on the bottom of the plunge.

### 5. Maintenance mode (spanner)

Press and hold for 3 seconds to put the bath into a maintenance mode - The LED light on the chiller and light in the bath will flash 3 seconds on 3 seconds off whilst in this mode. From here you can change the particle filter. Exit maintenance mode by pressing and holding for 3 seconds again. **\*Note under normal operating tasks, maintenance mode is not required\***

### Bath light

The light in the bath will remain on even when not in use. The light will flash when in maintenance/backwash mode. If the light flashes when not in one of these modes contact the support team.

# Spa 3 With Auto Backwash

## Parts Overview

### 1. Water skimmer

The always-on skimmer gently draws the water through a narrow opening, removing debris from the surface. The water then continues through the system for a deeper clean. The skimmer cover must be fitted for operation.

### 2. UV light filter

The water is passed through a UV light chamber, killing pathogens for a deeper clean. A digital screen below shows when your UV bulb next needs changing.

### 3. Media Filter with Automatic Backwash

The media filter removes fine sediment and organic material from the water to ensure clarity and safety. It includes a pressure sensor and gauge; when pressure drops below 0.3 kBa, the system can be backwashed at the press of a button to clean the filter.

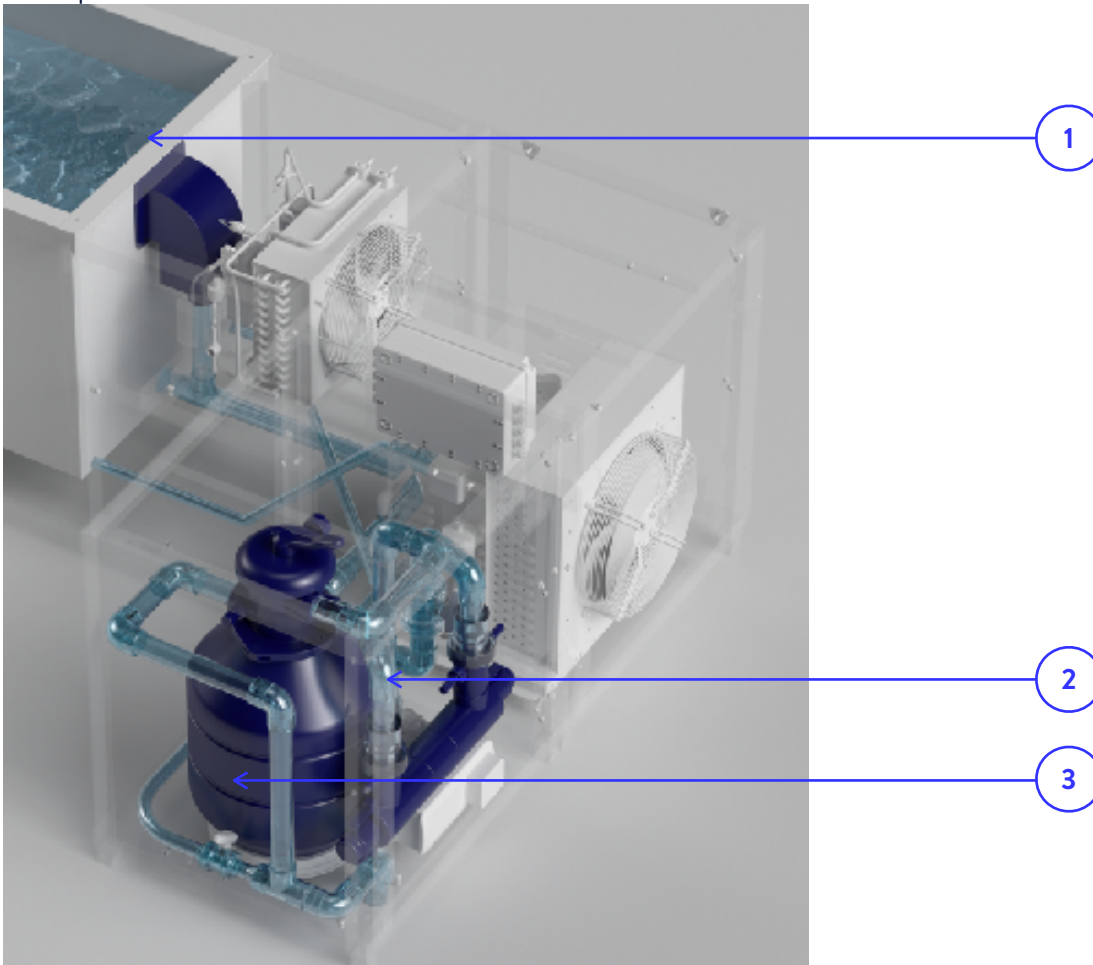

# Spa 3 With Auto Backwash

## Parts Overview (Continued)

### 4. Electronics Box

Contains our custom PCB with six sensor inputs that monitor the plunge and connected equipment. It powers and controls all components via our software, with an integrated Wi-Fi antenna. Dual-engine systems include two electronics boxes.

### 5. 2HP Chiller

A high-powered chiller that rapidly cools the water. After filtration, water passes through the heat exchanger and returns to the plunge via insulated PVC piping.

### 6. Hanna Auto Dose Unit

The Hanna Auto Dose Unit will dispense Chlorine and Acid to maintain water sanitisation and pH levels.

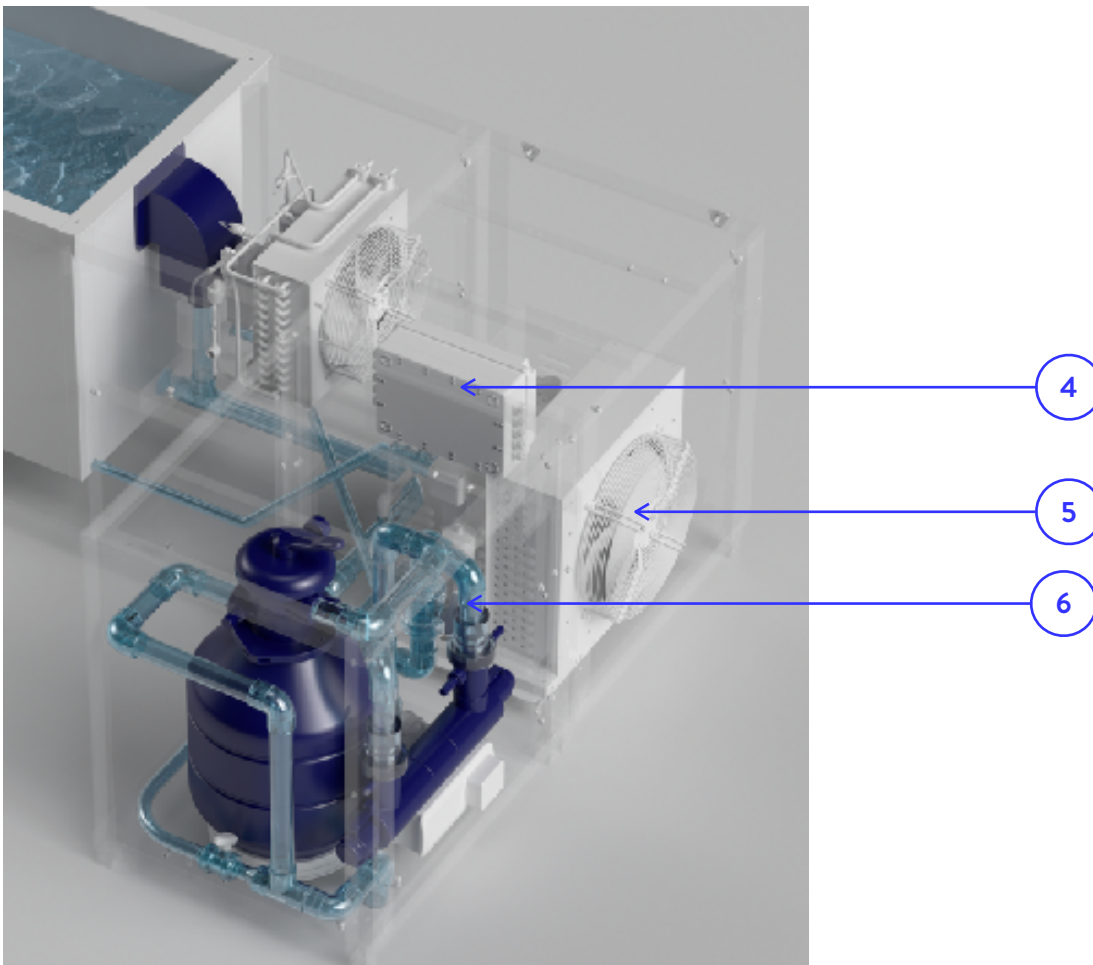

# Spa 3 With Auto Backwash

## Maintenance Tasks

|                        |   |
|------------------------|---|
| <b>EVERY DAY</b>       | <ul style="list-style-type: none"><li><input type="radio"/> Check &amp; clear</li><li><input type="radio"/> Water testing</li><li><input type="radio"/> Check Pressure for backwashing requirement</li><li><input type="radio"/> End of day wipe down</li></ul> |
| <b>EVERY WEEK</b>      | <ul style="list-style-type: none"><li><input type="radio"/> Full water change</li><li><input type="radio"/> Check &amp; balance water</li><li><input type="radio"/> Clean flow sensor</li></ul>   |
| <b>EVERY 4 WEEKS</b>   | <ul style="list-style-type: none"><li><input type="radio"/> Laboratory testing</li><li><input type="radio"/> System flush</li><li><input type="radio"/> Clean condenser</li></ul>   |
| <b>EVERY 3 MONTHS</b>  | <ul style="list-style-type: none"><li><input type="radio"/> Deep clean</li></ul>  |
| <b>EVERY 6 MONTHS</b>  |   |
| <b>EVERY 12 MONTHS</b> | <ul style="list-style-type: none"><li><input type="radio"/> Doser Service &amp; calibration</li><li><input type="radio"/> UV Bulb Change</li></ul>  |

 **Important:** Adjust frequencies of cleaning and maintenance protocols based on user load. It is essential that users shower before use.

# Pro 3 Single Filter with Auto Doser

## Parts Overview

### 1. Water skimmer

The always-on skimmer gently draws the water through a narrow opening, removing debris from the surface. The water then continues through the system for a deeper clean. The skimmer cover must be fitted for operation.

### 2. Hanna Auto Dose Unit

The Hanna Auto Dose Unit will dispense Chlorine and Acid to maintain water sanitisation and pH levels.

### 3. Particle Filter

This secondary filter collects the finer particles in the water down to 80 microns.

### 4. UV light filter

The water is passed through a UV light chamber, killing pathogens for a deeper clean. The UV is located behind the chiller unit.

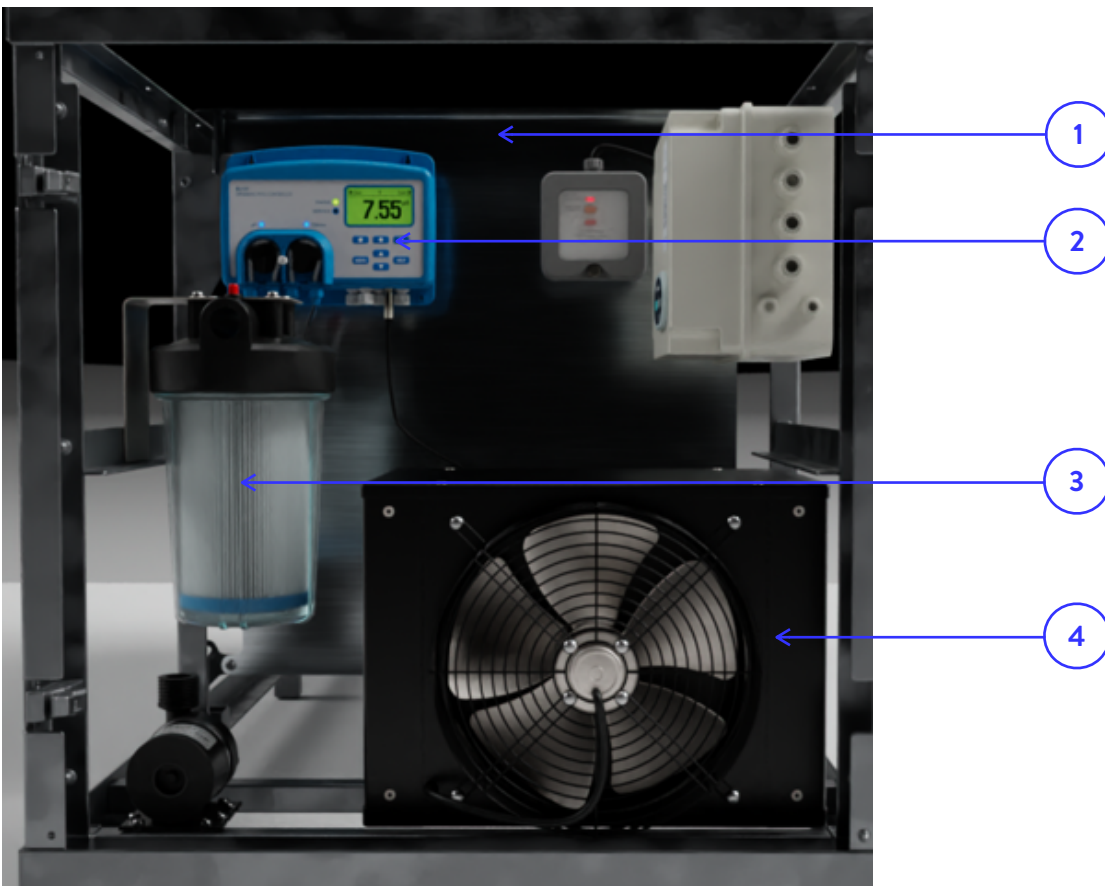

# Pro 3 Range

## Maintenance Tasks

|                        |  |
|------------------------|--|
| <b>EVERY DAY</b>       | <ul style="list-style-type: none"><li><input type="radio"/> Check &amp; clear</li><li><input type="radio"/> Water testing</li><li><input type="radio"/> End of day wipe down</li><li><input type="radio"/> Clean and replace particle filter <b>(Every 2 days)</b></li></ul> |
| <b>EVERY WEEK</b>      | <ul style="list-style-type: none"><li><input type="radio"/> Full water change</li><li><input type="radio"/> Check &amp; balance water</li></ul>  |
| <b>EVERY 4 WEEKS</b>   | <ul style="list-style-type: none"><li><input type="radio"/> Laboratory testing</li><li><input type="radio"/> System flush</li><li><input type="radio"/> Clean Condenser</li></ul>  |
| <b>EVERY 3 MONTHS</b>  | <ul style="list-style-type: none"><li><input type="radio"/> Deep clean</li></ul>   |
| <b>EVERY 6 MONTHS</b>  | <ul style="list-style-type: none"><li><input type="radio"/> UV Bulb Change</li></ul>   |
| <b>EVERY 12 MONTHS</b> | <ul style="list-style-type: none"><li><input type="radio"/> Doser Service &amp; calibration</li></ul>  |

 **Important:** Adjust frequencies of cleaning and maintenance protocols based on user load. It is essential that users shower before use.

# Section 4: Daily Tasks

## In this section...

- Clearing skimmer
- Clearing bottom drain
- End of day wipe down
- Check chemical levels and dosing unit
- Check pressure readings to backwash (for Spa 3 only)

# Check & Clear the Skimmer

## To be completed on ALL Brass Monkey products

Note:

These instructions are intended to cover a range of skimmer types and variations depending on model and purchase date. If you require instructions specific to your skimmer, please contact us.

1. Remove the skimmer cover:
  - If your skimmer cover has a thumb screw and separate tab at the top centre, unscrew it and put it safely aside. If not, proceed to the next step.
  - On the back of the skimmer cover are keyhole-style slots. Depending on model and purchase date, removal may require sliding the cover up or down.
2. Remove the basket:
  - Reach into the skimmer and lift out the basket.
  - Be aware that the basket may contain debris—do not empty it back into the water.
3. Clean the basket:
  - Rinse thoroughly until all debris is removed.
4. Replace the basket:
  - Return the basket to the skimmer with the large lip facing the front.
5. Replace the skimmer cover:
  - Align the cover with the lugs or slots and slide it back into position to secure it.
  - If your cover uses a separate tab and thumb screw, refit it, ensuring the additional tab is positioned with the groove closest to the bath.

 The skimmer cover is a safety feature. It **MUST** remain in place during use. If the cover is broken, removed or lost, ensure the bath is closed and request a replacement immediately.

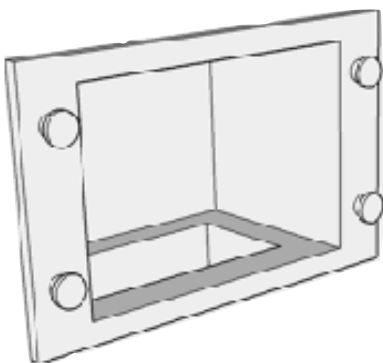

This is a view of the skimmer when placed on the bath

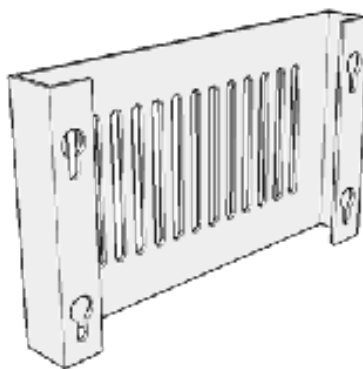

This is the back of the skimmer plate. The 4 holes are located onto bolts on the skimmer

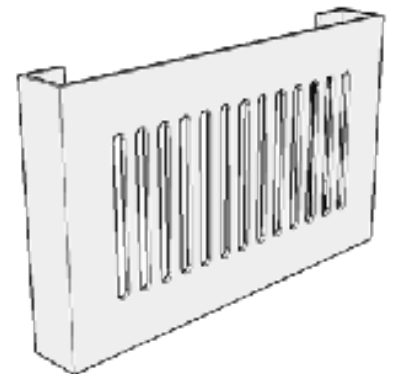

This is the front of the skimmer plate

# Check & Clear Bottom Drain

## To be completed on ALL Brass Monkey products

### Cleaning the Pre-Filter:

If debris are lodged into the filters you may need to drain the water down to a point you can reach the drain to remove it and give it a clean. Follow the relevant instructions to your drain.

### For Baths:

- Use the the tool provided, insert this into the drain by screwing it in. Once secure you can pull the drain out. Clean the filter under a tap using a stiff brush to remove any lodged debris (don't forget to take it off the removal tool for cleaning). Secure back to tool and to replace the drain filter back in place reach into the bath push it into the drain hole and then unscrew the removal tool.
- Unscrew this pre-filter, rinse under a tap and use a stiff brush to scrub and remove any lodged debris .

Your plunge will either have a drain and removal tool or a Pre Filter

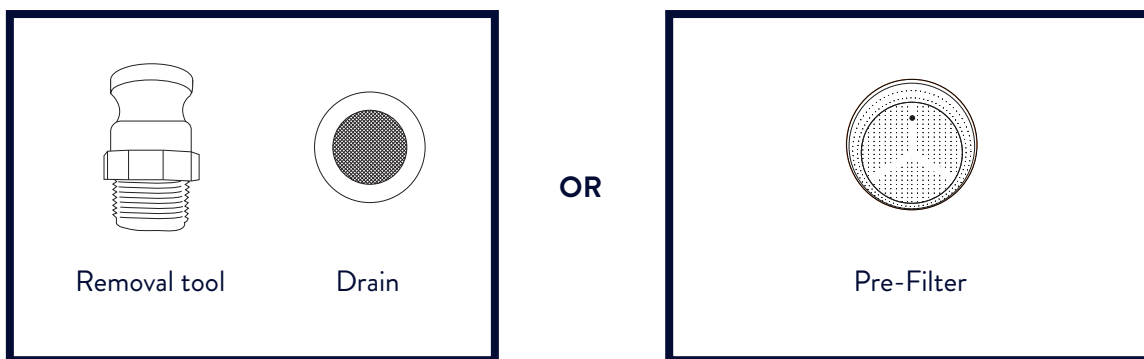

# End of Day Wipe Down

**To be completed on ALL Brass Monkey products**

**How to wipe down the bath:**

Wipe down and ensure all exterior parts of bath are clean and dried, including step and insulated top.

# Check Chemical Levels and Dosing Unit

**Check chemical bottle levels:**

Check that the chemical levels within the bottles are more than 1/4 full. Less than this and the dosing unit can pull up air into the line, if left to do this consistently it can turn the pipes brown.

Always check and ensure levels are topped up.

**Status and Service LED's:**

If the lights on the dosing unit are either amber or red it is signalling a problem.

Holding the HELP button will confirm what the problem is.

Please refer to the Hanna Manual for further information

# Backwash Media Filter

## To be completed on Spa 3 Brass Monkey products only

Allow 1 hour before the bath is used after backwashing as advised by PWTAG Technical note 71.

### How to know if a backwash is required:

The pressure through the media filter should be monitored regularly, as it indicates how clean or dirty the filter is. When the filter becomes dirty or clogged, the pressure through the system will decrease. When the filter gets clogged up the pressure will increase and the flow rate will decrease. Only backwash if required, expect this to be no more than every 3 days.

### Daily Check Procedure:

- Measure the pressure through the media filter.
- If the pressure has increased by 0.4 bar then complete a backwash
- If you have had a low flow or no flow alert via your app or bath flashing light, complete a backwash

If the pressure reading drops below 0.5 bar, this indicates reduced flow caused by blockage in the filter media – therefore, a backwash is required to clean the filter and restore normal operating pressure.

### Completing a backwash:

1. Before completing a backwash **open the fill valve** and allow the water to level to rise to the top of the skimmer.
2. Once water level is at the top of the skimmer **close the fill tap.**
3. Press the **Test button** on the media filter screen until the green lamp is illuminated. This will trigger a backwash.
4. Once the backwash has been completed the auto top up system will bring the water level back to the mid point automatically.

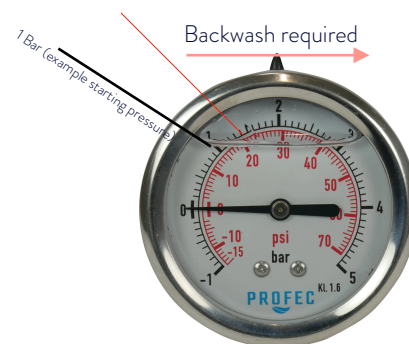

 If you notice air is being pulled into the skimmer please seek advise from Brass Monkey. Not doing so could cause damage to your unit and inefficient filtration.

# Section 5: Tasks Every 2-3 Days

**In this section...**

- **Change particle filter - Pro 3 Only**

# Change The Particle Filter

## To be completed on Pro 3 Brass Monkey products only

Depending on usage and hygiene, this may need to be done daily or every few days. It's essential that users shower before getting in.

- **Switch the bath off**
  - This can be done at the main isolator or via the red button on the RCD box
- **Shut Off Water Flow:**
  - Turn the two blue valves (labelled A and B) 90° so they are not inline with the pipes.
  - The isolation valves can be difficult to see, put your hand on the pipe to the left/right of the filter and follow this around until you get the valve.

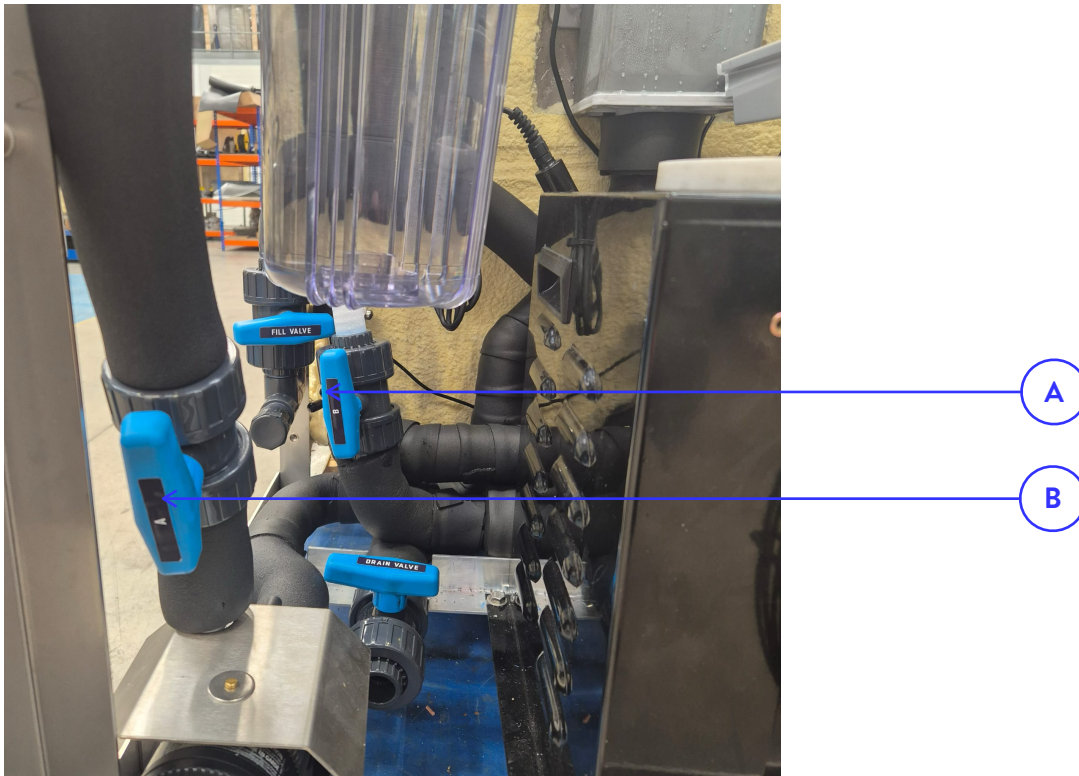

- **Open the Filter Housing:**
  - Remove the neoprene cover.
  - Use the filter key to loosen the housing.
  - Unscrew by hand—it will be full of water, so pour it out carefully.
  - Remove the filter and check the rubber ring stays in place at the top.

# Change The Particle Filter

## To be completed on Pro 3 Brass Monkey products only (Continued)

- **Clean or Replace the Filter:**

- Wipe inside the housing with a cloth.
- Rinse the plastic filter under running water, or insert a new paper filter if applicable.
- Make sure the rubber ring is fitted correctly.

- **Reassemble:**

- Insert the filter
- Screw the chamber back on by hand.
- Use the key to tighten slightly—do not over-tighten.

- **Restore Water Flow:**

- Turn the blue valves (A and B) back inline with the pipes.

- **Power the bath back on**

- If power was switched off at the main isolator, turn this back on
- If power switched on via the RCD unit, use the orange button to power back on

- **Confirm Operation:**

- Ensure the light is on and water is flowing.

# Section 6: UV Bulb Change

**In this section...**

- **Pro Unit UV Bulb Replacement**
- **Spa Unit UV Bulb Replacement**

# UV Bulb Access & Replacement - Pro 3

The UV bulb will be fitted by Brass Monkey during installation. However, please note that the bulb needs to be replaced every 6 months. It's a good idea to familiarise yourself with the system while setting up your unit for the first time.

## Location:

The UV unit is located behind the chiller/ice maker. The bulb exits on the right-hand side when facing the plant.

## Accessing the UV Bulb:

To access the bulb, you will need to:

- Remove the bath end panel.
- Remove the long panel on the right-hand side of the bath.

**Note:** If the right-hand side of the bath is positioned against a wall, you will need to move the bath away from the wall to allow access for bulb removal and replacement.

## Changing the bulb

- Turn the power off, this can be done by pressing the red button on the RCD
- Remove panels to gain access to right side of plant.
- Locate UV bulb chamber. Turn the chamber clockwise until it releases. Pull to remove the cap and bulb.

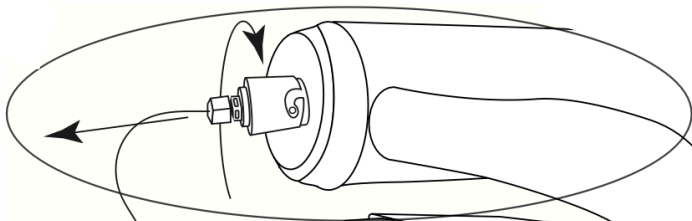

- Unplug the old bulb, plug in the new one. Take care not to touch the glass section of the new bulb.
- Slide new bulb into the chamber, push in the cap and screw shut.

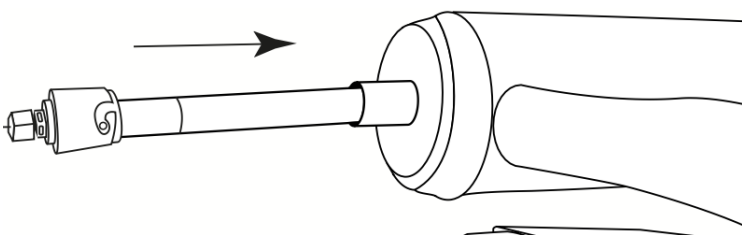

- Replace panels, and power back on by pressing orange button on RCD

# UV Bulb Access & Replacement - Spa 3

The UV bulb will be fitted by Brass Monkey during installation. However, please note that the bulb needs to be replaced every 12 - 2years. (Lamp life is 9000 hours) It's a good idea to familiarise yourself with the system while setting up your unit for the first time.

## Location:

The UV is located within the spa area.

## Accessing the UV Bulb:

To access the bulb, you will need to:

- Remove the side panel for the UV bulb to exit.

## Removing the bulb

- Turn the power off, this can be done by pressing the red button on the RCD
- Remove panels to gain access to the side of the UV.

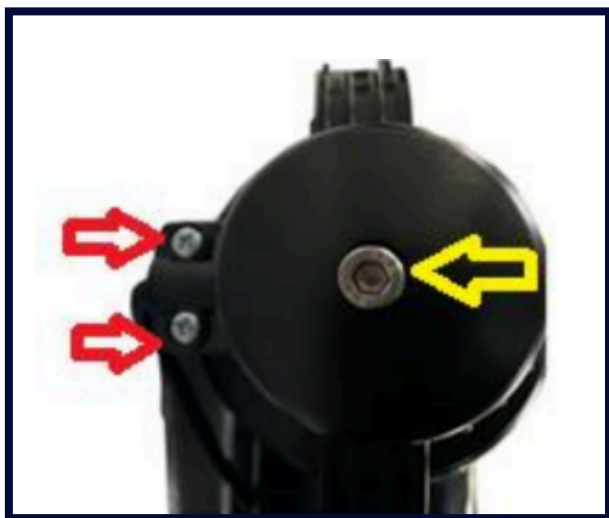

### Step 1.

Unscrew all the highlighted fasteners



### Step 2.

Unclamp the clip from the body by pulling the clip away from the body, one side at a time.

## Removing the bulb (continued)



### Step 3.

Remove the lamp holder clip from the hard cap.



### Step 4.

Unmount the hard cap from the blue lamp holder.



### Step 5.

Carefully remove the blue lamp holder shroud and white plastic electrical end caps from the lamp end

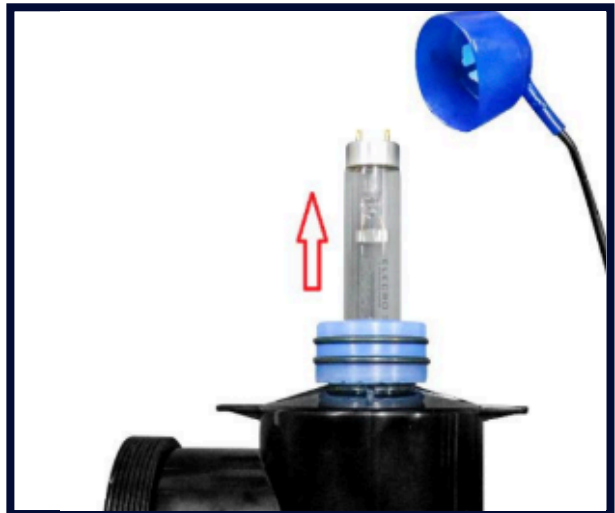

### Step 6.

Gently slide the lamp out ensuring that no pressure is applied to the glass quartz sleeve

## Removing the bulb (continued)

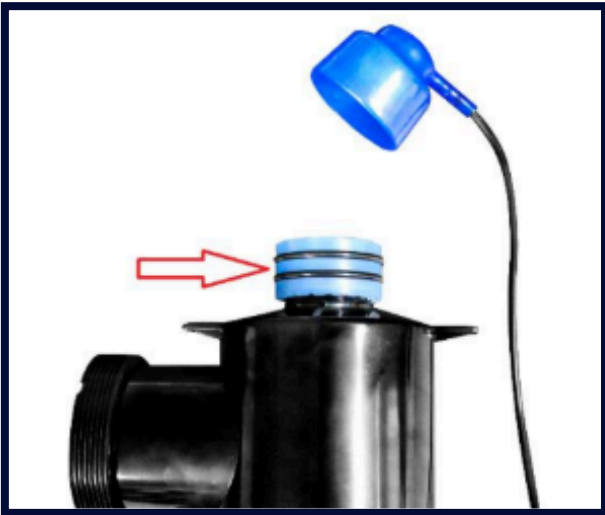

### Step 7.

Unscrew the blue quartz sleeve locking nut anti-clockwise. Both ends must be unscrewed before the quartz sleeve can be removed.



### Step 8.

Slide the O-ring off the quartz sleeve

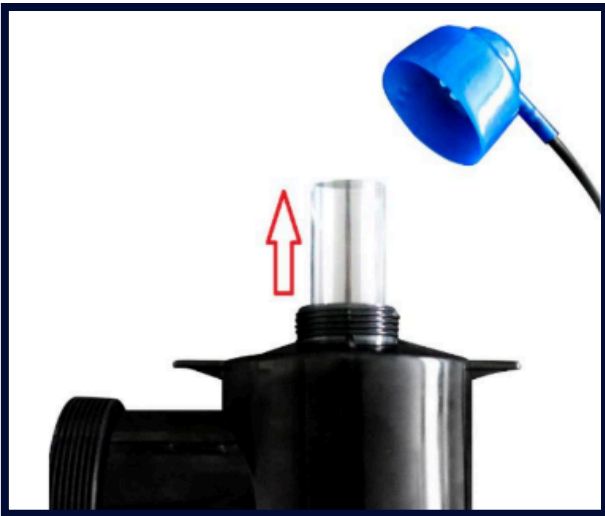

### Step 9.

The quartz sleeve can now be removed.

## Cleaning the quartz sleeve

Note this continues from the bulb removal

- Clean the sleeve and polish with a soft cloth or paper towel.
- If you live in a hard water area there may be some limescale on the quartz sleeve. This can be easily removed by soaking the sleeve in a proprietary kettle descaling solution (follow the manufacturer's instructions).
- NOTE: Failure to remove the limescale will limit the effectiveness of the UV lamp(s).

## Refitting the sleeve and bulb

- Firstly, slide the clean dry quartz glass sleeve into the unit.
- Locate the 'O' rings carefully on the ends of the quartz sleeve.
- Make sure the threads are clean, wipe a little silicone grease onto the threads. As these threads are only serviced periodically, this lubrication will help to prevent them binding together.
- Hand tighten the blue quartz sleeve locking nuts onto the unit. Be sure not to over tighten as this can damage the quartz sleeve.
- Replace the UV bulb with a new one and reconnect blue lamp holders.
- NOTE: To avoid bending the bulb pins during the reassembly, pull the plastic fitting out of the shroud. Connect it to the lamp and push the shroud back in to place.



NOTE: Pinch the blue lamp holder shroud as you reassemble the unit to release any trapped air. Failure to release the trapped air may cause the lamp holder to disconnect from the lamp end. Turn on the water supply to check for leaks before reconnecting the electric supply.

Important: The plastic body and blue compression fittings have been manufactured from polymers that have been specifically stabilised to protect them from the effects of the UVC emitted from the UV lamps. Despite this UV protection they will be eroded by a combination of the UVC and water flow. As a matter of course they should be inspected whenever a lamp change is carried out, to ensure they are not showing excessive wear and tear. Replacement parts are available.

# Section 7: Water Management

## In this section...

- Drain down and refill
- Daily water testing
- Weekly Check and balance water
- Monthly biological testing
- Cleaning the Flow sensor

# Drain Down & Refill

## To be completed on ALL Brass Monkey products

### To Drain:

If debris are lodged into the filters you may need to drain the water down to a point you can reach the drain to remove it and give it a clean. Follow the relevant instructions to your drain.

Before refilling consider completing the **deep clean** steps.

### To Refill:

The bath should have no power when empty.

- Open the fill valve and allow to fill until bath is filled to 1/3, if your unable to see the bath from your location we suggest timing this for the first time as water pressure varies from site to site
- Close fill valve
- Power on by pressing orange button on RCD.
- Check the bath is running, the light will be on and water will be flowing

## Spa Range Only

### Priming the Pump

Whenever the unit has been drained and refilled, the pump must be primed with water to make sure no air remains inside the pump. If air is left inside, it can damage the pump.

How to prime the pump:

1. Once the unit has been refilled, locate the clear top on the pump.
2. Loosen the clear top carefully.
3. Wait until you can see water appear in the pump area.
4. Once water is visible, tighten the clear top securely.
5. Check that it is fully closed before operating the unit.

If the clear top is difficult to loosen, a pump lid removal tool can be purchased to make this easier.

# Test & Dose

## Chlorine and pH Levels

### Target Levels:

- Chlorine: 2–4 ppm (safe range) (Minimum level 1, Maximum level 5)
- pH: 7.0–7.4 (ideal: 7.2)

### When to Test:

- Before opening
- Regularly during the day (Every 2 hours)
- At the end of the day

### Step 1: Collect a Water Sample

- Use clean testing equipment.
- Take the sample about 30 cm below the surface.
- Seal immediately and record air & water temperature on the log.

### Step 2: Test the Sample

Follow the test kit instructions to measure:

- Free Chlorine (DPD1)
- Total Chlorine (DPD3)
- Combined Chlorine
- pH

Record all results on the Daily Water Quality Test Log - can be downloaded from our website

### Step 3: Check Results & Take Action

- 2–4 ppm chlorine: OK to use.
- >5 ppm: Too high — stop dosing, close pool, dilute, and retest.
- <0.5 ppm: Too low — close pool, add small chlorine doses (e.g., in skimmer), wait 15 minutes, and retest.
- Record water clarity in the same log.

# Check & Balance Water - Weekly

Balancing water helps prevent scale or corrosion. Use the Langelier Saturation Index (LSI) weekly to check overall balance.

## Step 1: Take Readings

Collect a water sample (30 cm depth) and record the following:

- Temperature = T Factor
- Total Alkalinity = A Factor
- pH
- Calcium Hardness = C Factor

Use calibrated meters or test kits for accuracy.

## Step 2: Record & Calculate

Record results on the Weekly Water Test Log (available via QR code).

Use this equation to calculate your Water Balance Index (LSI):

$$(T. \text{ factor} + C. \text{ factor} + A. \text{ factor} + \text{pH}) - 12.1^{**} = \text{LSI}$$

Compare your result to the guide below:

| Level        | Meaning               |
|--------------|-----------------------|
| 0.5          | Scale forming         |
| +0.2 to +0.5 | Acceptable balance    |
| 0.2          | Aim for +0.1          |
| -.01 to +0.1 | Ideal balance         |
| -0.1 to -0.5 | Acceptable balance    |
| -0.5         | Corrosive and erosive |

## Step 3: Adjust if Needed

- Outside range: Dilute water until balance is acceptable.
- Within range: No action required.
- Record any adjustments made on the weekly log.

For further information or guidance refer to PWTAG Technical note 71. [www.pwttag.org/ice-baths-tn71/](http://www.pwttag.org/ice-baths-tn71/)

# Check & Balance Water - Weekly

| What                     | Ideal Level                | Actions  |
|--------------------------|----------------------------|--|
| <b>pH Balance</b>        | 7.0-7.4 (Best at 7.2)      | <ul style="list-style-type: none"> <li>• Low pH: Causes irritation and corrosion.</li> <li>• High pH: Cloudy water, weakens chlorine.</li> <li>• Adjust with chemicals or fresh water.</li> </ul>  |
| <b>Alkalinity</b>        | 80-120 ppm.                | <ul style="list-style-type: none"> <li>• Stabilizes pH.</li> <li>• Adjust alkalinity first, then recheck pH.</li> </ul>  |
| <b>Free Chlorine</b>     | 2-4 ppm <br>Min 1<br>Max 5 | <ul style="list-style-type: none"> <li>• Upper limit: 3mg/L.</li> <li>• If too high, reduce dosing or dilute water.</li> </ul>   |
| <b>Combined Chlorine</b> | < 50% of free chlorine.    | <ul style="list-style-type: none"> <li>• Upper limit: 1mg/L.</li> <li>• If too high, dilute water (drain and top back up).</li> <li>• Check pre user hygiene is being carried out</li> <li>• For repeated issues consider shock dosing and completing a system flush targeting biofilm and grease</li> </ul> |
| <b>Calcium Hardness</b>  | 75-150mg/L.                | <ul style="list-style-type: none"> <li>• High levels cause scaling.</li> <li>• Test weekly.</li> </ul>   |
| <b>TDS</b>               | Keep under 1000mg/L.       | <ul style="list-style-type: none"> <li>• Test weekly, reduce by dilution.</li> </ul>   |
| <b>Sulphates</b>         | Less than 360mg/L.         | <ul style="list-style-type: none"> <li>• Test weekly.</li> </ul>   |

# Biological Testing

Pool Water Treatment Advisory Group (PWTAG), commercial ice baths should be microbiologically tested each month by an ISO 17025 UKAS-accredited laboratory. The required tests include:

- Aerobic colony count (37 °C)
- Coliforms
- E. coli
- Pseudomonas aeruginosa

## What to do when the results are in?

If the results show your maintaining good levels of water sanitation then continue as you are remembering to adjust your regime as and when required.

## If the results show concerning levels of bacteria follow the following:

- Complete steps for **Full drain and deep clean**.
- Seek to understand why the results aren't as you expected:
  - Review the daily and weekly water logs.
  - You may need to increase the frequency of your maintenance regime.
  - Ensure bathers are following pre-showering.
  - Ensure other areas of the bath are being cleaned eg. The step, the insulated cover

 Biological testing in the UK can be organised through Brass Monkey. Get in touch for further information

# Cleaning the Flow Sensor

The flow sensor is located below the Hanna dosing system, towards the rear of the unit. This should be checked weekly to ensure no debris or dirt becomes trapped inside the flow sensor and affects the unit's flow.

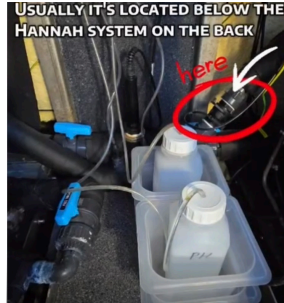

How to clean the flow sensor

1. Locate the retaining clip and remove it. Always pull the clip straight up, not sideways, to avoid damage.
2. Separate the housing to create two parts.
3. Locate the white spinner inside the sensor and remove it.
4. Clean the spinner and the inside of the housing, ensuring there is no debris or dirt present.
5. Reassemble the spinner in the correct order:
  - The middle piece goes into the bottom section with the wider side facing up.
  - The top piece clips into the bottom part.
  - The middle section should spin freely once assembled.
6. Place the spinner back into the flow sensor housing.
7. Reconnect the two housing parts and ensure the seal is correctly positioned.
8. Reinsert the retaining clip and push it fully down to secure the unit.

# Section 8: Understanding the Hanna Dosing Unit

## In this section...

- What it is / how it works
- Safety measures
- Chemical information
- Dosing unit
- Operation
- Common questions
- Fitting the sensor
- Chemical set up
- Priming dosing lines
- Calibration of probe
- Settings/ parameters
- Password protection

# Hanna BL121

## About the Controller

The BL121 Swimming Pool Controller is an all-in-one system for automatically maintaining the pH and chlorine levels. It features a multi-parameter digital probe to ensure stable, accurate measurements and two built-in chemical feed pumps for precise dosing of acid and chlorine.

The controller includes advanced features like a dosing consent system to prevent chemical wastage, a built-in data logger for compliance monitoring, scalable analogue outputs for external devices, and real-time graph displays.

With programmable alarms and password protection, it provides a reliable and efficient solution for water quality management.

## Chlorine & pH Balance

The automatic tester and dosing system uses an advanced ORP (Oxidation-Reduction Potential) probe to measure the effectiveness of chlorine in the water. ORP is expressed in millivolts (mV) and indicates how efficiently chlorine is sanitising the system, rather than just the amount present.

We recommend maintaining chlorine levels between 1–3 ppm for optimal water quality. ORP provides an accurate reflection of disinfection performance, ensuring safe and hygienic conditions.

pH balance is also crucial for chlorine effectiveness. The system monitors pH, and we advise keeping levels at 7.2 for optimal performance, within an acceptable range of 7.0-7.4.

## Further Information

The Hanna Instruments manufacturers manual can be downloaded from them on - <https://www.hannainstruments.nl/mediastorage/FSDocument/A2670000/2679925/manual-bl121-en.pdf>

# Safety Measures

- Do not use chlorine tablets, granular chlorine or other non-liquid chlorine applications with the Hanna
- Do not use the controller in a plunge utilising electrolytic chlorine generation (salt electrolysis).
- Do not add stabiliser (e.g. cyanuric acid) to the plunge while using the controller. To remove stabiliser from the plunge, the plunge must be drained and cleaned.
- Always disconnect the controller from power when making electrical connections.
- Do not access the larger rear panel.
- Do not run other cables with the power cable through the cable gland.

## Recommended Chemicals

### Chlorine:

Sodium Hypochlorite (available in 11-12% or 14-15%)

### Acid (to control pH):

Sulphuric Acid no more than 16% strength

### Further Information

The manufacturers instruction manual is supplied on delivery of your Brass Monkey Product.

If you require a copy this can be downloaded at:

[https://www.hannainst.com/hubfs/product-manuals/MANBL12X\\_03\\_20.pdf](https://www.hannainst.com/hubfs/product-manuals/MANBL12X_03_20.pdf)

# Chemicals

- **Chlorine:** Sodium Hypochlorite (available in 11–12% or 14–15%). - Can be supplied through Brass Monkey
- **pH Control:** Sulphuric Acid (no more than 16% strength) - Can be supplied through Brass Monkey

## General Tips

- Use a designated, well-ventilated plant room for handling.
- Make sure there's easy access to an eyewash station and safety shower if needed.
- Always keep neutralising agents handy for spills (e.g., baking soda for acid spills).

## Chlorine (Sodium Hypochlorite):

### Storage:

- Store in a cool, dry place, away from sunlight and heat.
- Keep it in its original container (HDPE or polyethylene) and ensure it's tightly sealed.

### PPE:

- **Gloves:** Wear chemical-resistant gloves (nitrile or rubber).
- **Eye Protection:** Use safety goggles or a face shield.
- **Clothing:** Wear an apron or protective clothing to prevent splashes.
- **Ventilation:** Ensure the area is well-ventilated, or wear a mask if fumes are present.

## Sulphuric Acid:

### Storage:

- Keep it in a cool, dry area, away from heat.
- Store in a corrosion-resistant container (polyethylene or polypropylene) and tightly sealed.

### PPE:

- **Gloves:** Use rubber or nitrile gloves.
- **Eye Protection:** Safety goggles or a face shield.
- **Clothing:** Wear protective clothing or an apron to protect your skin.
- **Ventilation:** Ensure proper ventilation, or use a mask if needed.

# Get to know Hanna

The front panel features a custom display, tactile keypad, and LED indicators. The display shows measurements and temperature, while LEDs signal alarms, service needs (red), and pump activation (blue).

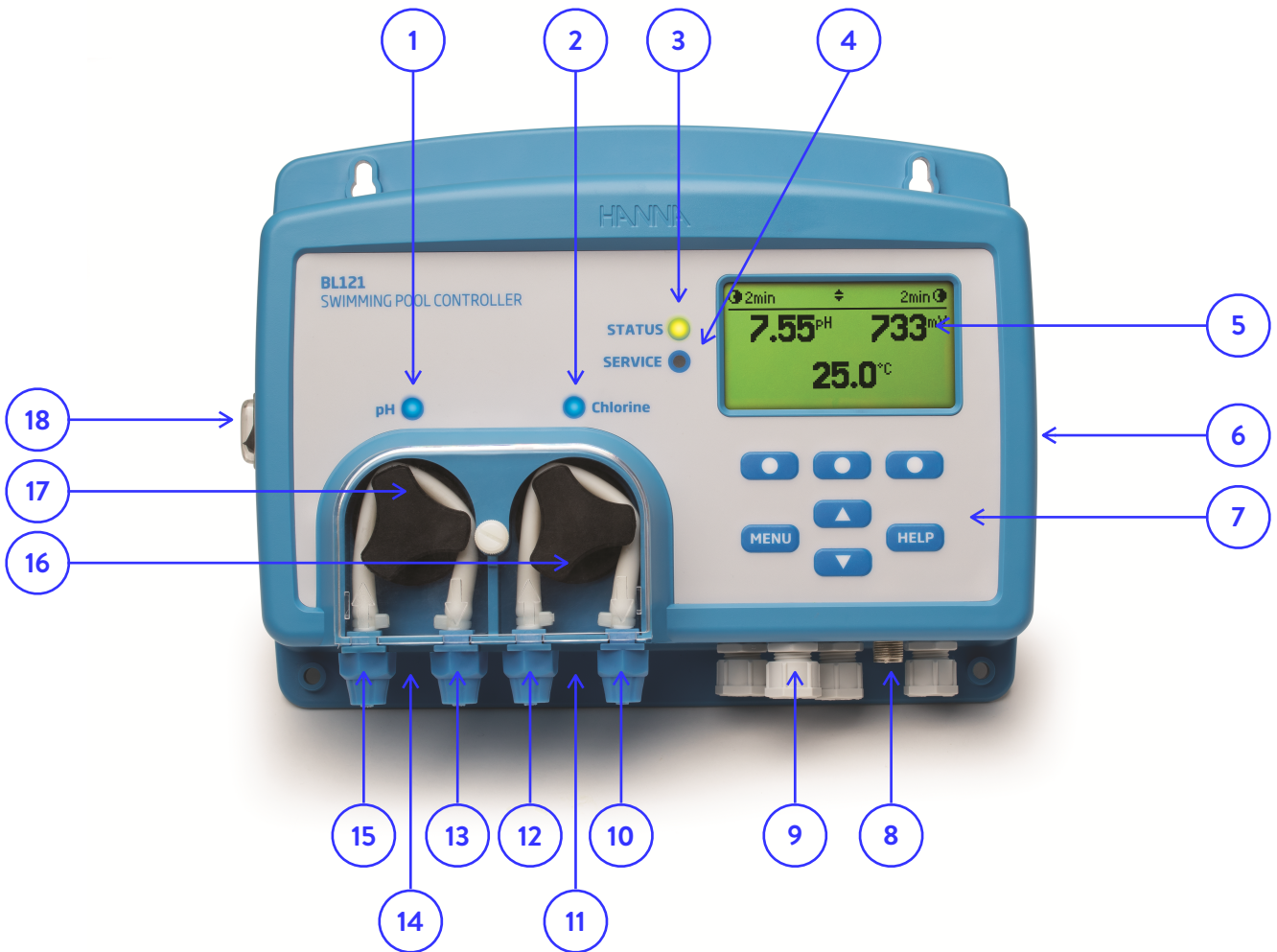

- |                                 |                          |
|---------------------------------|--------------------------|
| 1. Acid Pump Status LED         | 10. Chlorine OUT         |
| 2. Chlorine Pump Status LED     | 11. Drainage Hole        |
| 3. Status LED                   | 12. Chlorine IN          |
| 4. Service LED                  | 13. Acid OUT             |
| 5. Liquid Crystal Display (LCD) | 14. Drainage Hole        |
| 6. USB Port (Host)              | 15. Acid IN              |
| 7. Keypad Area                  | 16. Chlorine Dosing Pump |
| 8. Probe Connector              | 17. Acid Dosing Pump     |
| 9. Cable Gland Seals            | 18. Power Switch         |

# Get to know Hanna

## The Control Pad

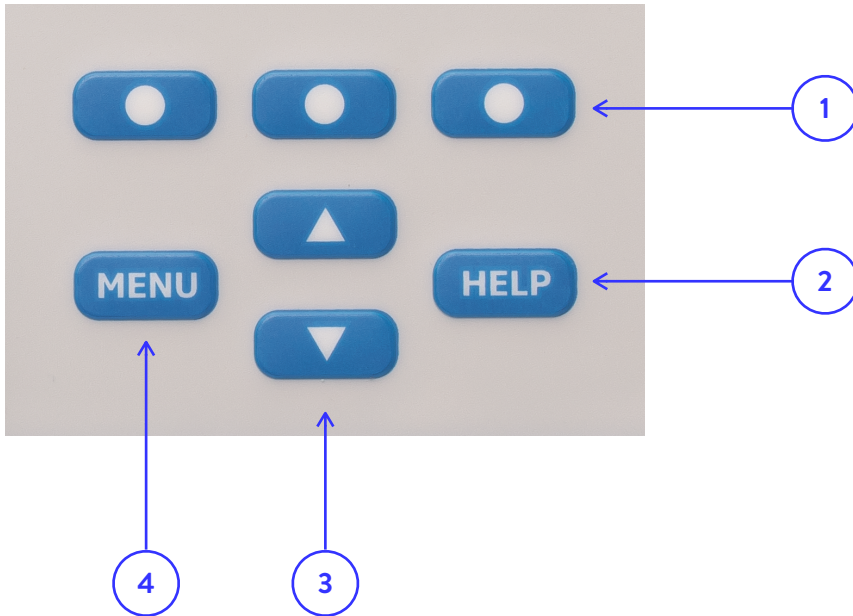

1. **Function Keys:** These 3 buttons function contextually
2. **Help Key:** Press to enter or exit the Help Menu
3. **Up & Down Keys:** When in MENU mode, press the arrow keys to scroll the menu items / adjust the settings – When in measurement mode, press the arrow keys to change the screen: three parameter screen (pH, ORP, temperature), single parameter screen and plot display
4. **Menu Key:** Press MENU key to enter setup mode and access manual pump control; pH/ORP/Temperature options

# Get to know Hanna

## In-Line Installation Overview & Components

Below is an illustrated reference of a generic, in-line installation scheme with the relevant components.

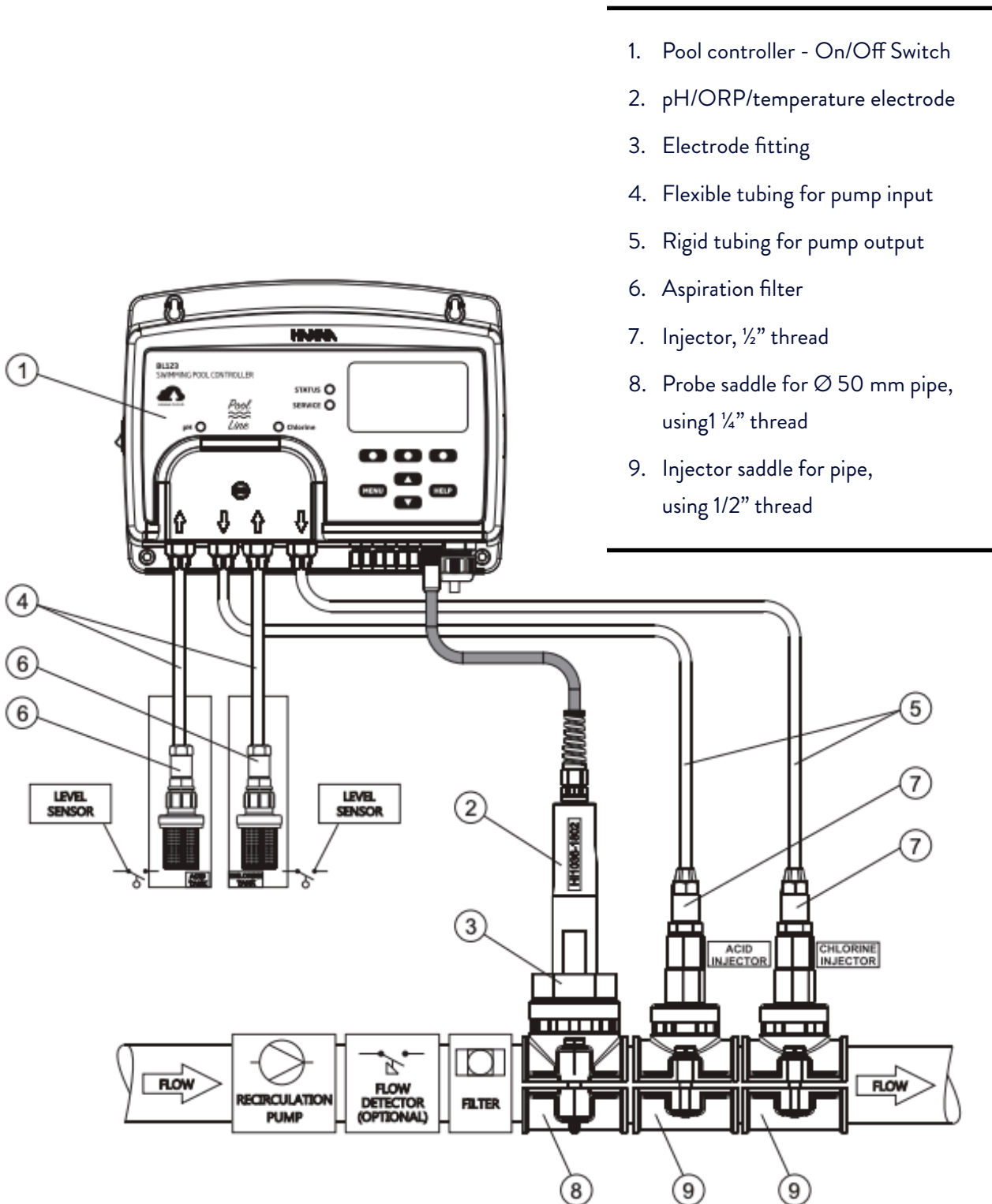

# Operation

## Set-up & Calibration

The Hanna unit will be calibrated and set up by Brass Monkey, ready to be switched on.

Once the settings have been checked and the probe has been calibrated the unit is ready to use.

- Ensure the liquid containers are labelled correctly and filled with the correct fluid.
- Ensure the dosing line from the pH pump goes into the correct chemical bottle and the same with the C12 pump (chlorine).
- Ensure the bath is running and out of maintenance mode - if the bath is in maintenance mode exit this by holding the spanner button on the main control board for 3 seconds.

## Chlorine & pH Levels

Levels as outlined by PWTAG (Pool Water Treatment and Advisory Group) Technical Note. 71

Chemistry Testing should be done with a photometer or comparator that is checked and calibrated in line with the manufacturer's guidance. The water should be tested (disinfectant levels and pH values) before users get in, then every two hours. For a chlorine-based disinfectant the levels should be:

- free chlorine, 1.0mg-5.0mg/l
- pH value 7.0 - 7.6.

### Brass Monkey advice - Chlorine and pH Levels

- Free Chlorine: The ideal level is 2-4 ppm.
- Total Chlorine should be measured so that Combined Chlorine can be calculated.
- (Total Chlorine - Free Chlorine = Combined Chlorine)
- The aim is for combined Chlorine to be less than the Free Chlorine
- PH Balance: The optimal range is 7.0-7.4, with 7.2 being the target.
- These measurements should be taken:
  - Before opening
  - Regularly throughout the day to ensure levels remain stable.
  - At the end of the day, especially after completing any maintenance tasks.

# Questions

## **Is ORP the same as Parts per million?**

No, ORP is not the same and does not directly influence ppm but they are closely related.

- PPM (Parts Per Million) measures the amount of chlorine in the water.
- ORP (Oxidation-Reduction Potential) measures how effective that chlorine is at sanitising.

You could have a high ppm but low ORP if the chlorine is not working efficiently (due to high pH, organic contaminants). Similarly, you could have a lower ppm but high ORP if conditions are ideal for chlorine to work effectively.

So, while ORP and ppm are linked, one does not directly control the other—ORP reflects how well the available chlorine is disinfecting, while ppm tells you how much chlorine is present.

## **Do I still need to test the chlorine levels in the bath?**

Yes! Absolutely! As ORP and parts per million are not the same you will need to continue testing your water on a regular basis throughout the day. We advise that the PPM should be between 2-4, anything over 5 is dangerous and should result in immediate closure of the bath to resolve. For daily water testing. We recommend the HI-97710c - Most accurate and can be calibrated by the user. You will need the reagents HI -93701-T to go with this for testing.

## **What to do if I am switching brand or strength of chemicals?**

The unit does not require recalibration, but the injection lines should be flushed before switching chemicals.

1. Remove the lines from the chemical bottles and place them in a large jug of water (approximately 1 litre).
2. Press the Menu, scroll to Acid Pump, and press the left circle button under On 10s to run the pump for 10 seconds.
3. Continue pressing this button until the lines are flushed of the old chemical.
4. Repeat the process for the C12 pump.
5. You can now swap the bottles over with the new chemicals. Using the On 10s on the pump you can prime the dosing lines.
6. We recommend draining the plunge and refilling it with fresh water to avoid mixing chemicals.
7. This will ensure the dosing system starts with a clean slate.

# Questions

## How often does Hanna need calibrating?

Calibration should be completed every 12 months.

## What do I do if my pH or Chlorine levels are not within the parameters you advise?

The set points on the Hanna system are going to be unique to you.

The Hanna set points will be set to the points that will work best for you.

If you find through routine Free Chlorine testing you need to increase the amount of chlorine this can be done by:

1. Press Menu on the Hanna unit.
2. Scroll down using the arrows until you reach ORP options.
3. The current ORP setpoint should be 740mV.
4. Press Set, then adjust the number up or down
5. Always re-rest the water after a minimum of 20 minutes to check the effect of the adjustment

| Menu        |           |
|-------------|-----------|
| Acid Pump   | AUTO ▲    |
| Cl2 Pump    | AUTO ▼    |
| pH Options  |           |
| ORP Options |           |
| CAL         | Setup GLP |

| ORP Setup         |         | 6 |
|-------------------|---------|---|
| Set Point         | 700 mV  | ▲ |
| Proportional Band | 100 mV  | ■ |
| Cl2 Flow Rate     | 2.2 L/h |   |
| Overtime          | 30 min  | ▼ |
| ESC               | Set     |   |

|                       |          |                          |
|-----------------------|----------|--------------------------|
| Alarm High            | 900 mV   |                          |
| Alarm High            |          | <input type="checkbox"/> |
| Alarm Low             | 200 mV   |                          |
| Alarm Low             |          | <input type="checkbox"/> |
| Warnings and Errors   |          | <input type="checkbox"/> |
| Alarm Activates Relay |          | <input type="checkbox"/> |
| Startup Dosing Delay  | 5 min    |                          |
| Analog out            | Disabled |                          |
| Max. Analog Out       | 2000mV   |                          |
| Min. Analog Out       | -2000mV  |                          |
| Cl2 Tank Input        |          | <input type="checkbox"/> |

# Questions

## **How often should I check the Hanna system?**

You should include checking the Hanna system as part of your regular water testing regime.

You should check:

- Chemical bottles are not empty
- For any warnings or error messages

## **Can I recall the test logs?**

Yes! You can recall the test logs from the Hanna system at the end of each day. Please refer to the manual provided by Hanna Instruments for this. Please note, you will need a USB.

## **Can I lock the Chlorine and pH set points so only one person can adjust them?**

Yes! Please refer to the manual provided by Hanna Instruments for this. You will need to pick a password, if you forget your password Brass Monkey will not have this on record.

## **When I go into settings the screen asks me if I want to go into HOLD mode.**

Say YES, this will stop the unit from trying to dose whilst you are adjusting settings.

## **My chemical levels don't seem to be right but I have checked my set points**

- Check that the dosing lines are in the correct chemical baths
- Check the settings on the Hanna match the parameter tables within this document.

If some settings are incorrect the Hanna unit might stop dosing, an example of this is if the Alarm High/Low on the temperature setting is enabled and the temperature is hit, the Hanna unit will stop dosing. This is why we disable the alarm.

- Check that the drain hasn't been left open or if you have a media filter that the handle is in the correct position. If water is slowly escaping to waste the auto top up may maintain the water level and explain why you are seeing a reduction in chlorine levels.
- If the bath is freshly filled or not in use (meaning water is clean) bacterial activity will be minimal, meaning the chlorine demand is also low. In this situation, it's likely you'll need to carry out a manual chlorine dose on a routine basis whilst the bath is not in use to maintain higher chlorine levels.

# The Hanna Doser

## Fitting the sensor

The Hanna dosing unit is installed into all commercial units from March 2025 as standard.

Due to transportation we do not install the sensor into the pipework, instead it is fitted with a protective cap which requires removing before being inserted into the pipework.

**Before the bath is filled and before you have switched the power on...**

1. Locate the injector lines, near these will be a screw cap. Unscrew this as this is where the sensor probe will be secured.

 **Keep the cap** - You will need this in the future when you need to remove the probe for calibration. Keep it safe.



Typical Spa Set Up

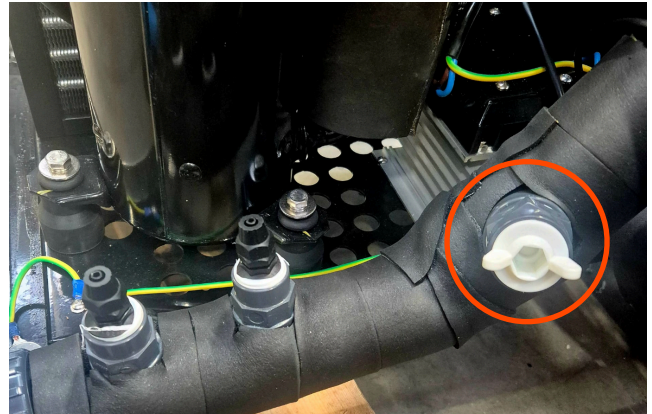

Typical Pro Set Up

2. Remove the protective cap from the sensor.
3. Ensure the O ring stays in place on the sensor
4. Insert the sensor probe and screw carefully into the saddle.

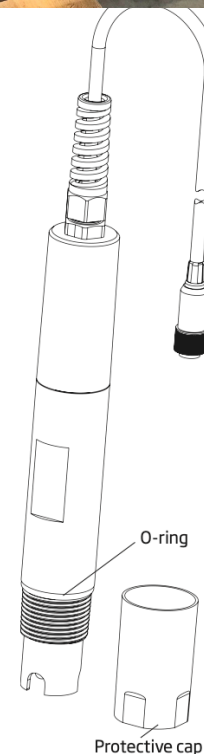

# The Hanna Doser

## Chemical Set Up

The dosing unit contains two pumps: one labelled pH and one labelled Chlorine.

- Each pump has two lines:
  - Injection line – this line runs from the dosing unit into the pipework and is pre-installed by Brass Monkey.
  - Suction line – this line draws chemical from the bottle and is pre-fitted to the bottle lid and aspiration filter.



Injection Points

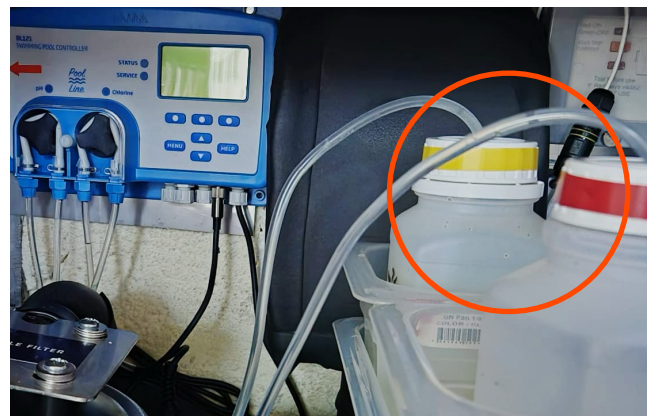

Suction lines

**You will receive a total of four bottles:**

- 2 with Yellow markings – for Chlorine
- 2 with Red markings – for Acid (pH)

### Labelling

As the operator, you must clearly label each bottle with the name of the chemical it will contain.

# The Hanna Doser

## Chemical Set Up (continued)

There are two types of bottle lids provided:

- Perforated lids (with holes):
  - Fitted with injection lines and aspiration filters
  - These lids stay inside the unit at all times
  - One Yellow and one Red bottle will use these lids
- Solid lids (no holes):
  - Used for safely transporting chemicals
  - One Yellow and one Red bottle will use these lids
  - Fill these bottles in your designated safe area
  - Once filled and sealed, transport them to the bath
  - At the bath, swap the solid lid for the perforated lid (which remains with the dosing system)

### Connecting the Dosing Lines

Before connecting any lines, trace each line back from the dosing unit to identify its purpose:

- The pH line must be connected to the Red (Acid/pH) bottle
- The Chlorine line must be connected to the Yellow (Chlorine) bottle



It is critical that each dosing line is connected to the correct chemical to ensure safe and accurate operation of the system.

# Priming the Dosing Lines

Priming the dosing lines helps pull chemical from the bottles quickly through the lines to the dosing point, rather than waiting for normal operation to do so.

 **Important:** - Priming can only be done once the full setup is complete and the bath is switched on.

If the bath is in maintenance mode, the Hanna dosing unit will remain off—even if the switch on the unit is in the ON position.

## How to prime the lines

1. Press the Menu button on the dosing unit.
2. Scroll to the correct pump:
  - Select C12 Pump for Chlorine
  - Select Acid for pH
3. Press the left circle button under “On 10s”.
4. A 10-second countdown will begin.
5. Watch the suction line connected to the Chlorine or Acid bottle.
  - This step confirms that the correct chemical is connected to the correct line:
    - Acid → Acid line (Red)
    - Chlorine → Chlorine line (Yellow)
6. You can keep pressing “On 10s” to extend the run time in 10-second intervals.
  - Keep watching the chemical rise through the suction line.
  - When the chemical reaches the dosing unit, press Off on the pump.
7. Repeat this process for both lines – Acid and Chlorine.
8. Before completing ensure both pumps are switched back to AUTO

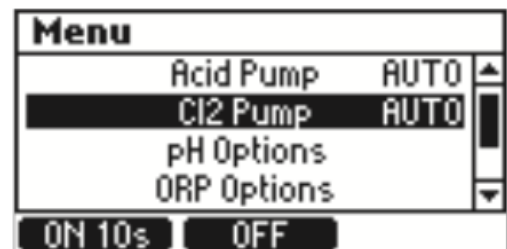
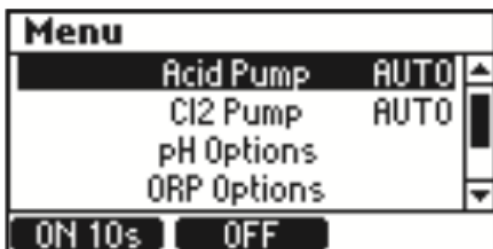

# Calibrating the Hanna Probe

**Every 12 months the unit will require re-calibrating.**

**To complete the calibration you will need to have:**

- Chemical Safe Gloves
- Chemical Safe Cup
- Towel
- Recalibration Chemical Kit Packets
- Two Red Packet (pH 4.01)
- Three Green Packet (pH 7.01)
- Three Black Packet (470 mV ORP Test Solution)

## Getting ready for calibration

### Access the Probe

- You may need to remove the side panel to reach the sensor probe – refer to the correct section of the manual for how to do this.

### Switch off the bath

- Press and hold the red button on the RCD unit to switch off the bath

### Isolate the Probe

**SPA models:** Turn the blue taps on either side of the probe so they are not inline with the pipe. This isolates the probe.

**PRO models:** These don't have isolation taps. You must drain the bath before removing the probe, otherwise the bath will empty through the open fitting.

### Remove the Probe

- Unscrew the silver collar from the Hanna controller (this prevents the cable from twisting).
- Carefully twist out the probe from the pipe.
- Hold a chemical-safe cup under the probe as you remove it to catch any water.

## Getting ready for calibration (continued)

### Remove the Probe (Continued)

- Place the probe in the cup with the water to keep it wet. Do not leave it out of water for more than 15 minutes.
- Ensure the silver collar is fitted back on to the Hanna controller - it needs to be connected to the unit throughout the calibration process

### Seal the Open Port

- Fit the protective cap (that came with the probe) into the pipe where the probe was removed.

### Refill if Needed

**SPA:** Turn the blue taps back inline with the pipe.

**PRO:** Open the fill valve and refill the bath about  $\frac{1}{4}$  full.

- Fit the skimmer bung to stop air being pulled through the skimmer.
- No need to fully fill the bath now, as you'll need to drain it again after calibration to refit the probe.

### Power the bath back on

- Press and hold the orange button on the RCD, the Hanna unit will power back on
- You are now ready to start the calibration

# Calibrating the Hanna Probe - pH

 **Important:** When you go into settings the screen will ask if you want to go into HOLD mode.

This will stop the unit from trying to dose. SAY YES

## Step 1: pH Calibration Calibrating with the 7.01 pH Solution (Green Packet)

- Press "Menu" on the auto-doser controller.
- Scroll to "pH Options"
- Press the left blue circle button under "CAL" to begin calibration.
- Open a 7.01 pH solution packet and fully submerge the end of the probe in the liquid. Hold it upright and steady.
- Wait for the reading on the screen to adjust.
- Once the numbers begin to stabilise, transfer the probe into a new 7.01 pH solution packet. (Using two sachets ensures a more accurate reading.) \*If the reading is within 0.01 of the target a second packet is not needed.
- When the numbers stabilise completely, "CFM" (Confirm) will appear in the lower right corner of the screen. This means the probe is calibrated to approximately 7.01. (This process should take around 2–3 minutes.)
- Press the right blue circle button under "CFM" to confirm.

## Step 2: Calibrating with the 4.01 pH Solution (Red Packet)

- The screen will now prompt you to continue with the 4.01 pH solution (red packet).
- Open a 4.01 pH solution packet and fully submerge the probe in the liquid, holding it upright and steady.
- Wait for the reading to adjust, then transfer the probe into a new 4.01 pH solution packet. (This removes any residue from the previous solution, ensuring an accurate reading.)
- When the numbers stabilise, "CFM" (Confirm) will appear in the lower right corner of the screen. (This process should take around 1–2 minutes.)
- Press the right blue circle button under "CFM" to confirm.

## Final Steps

- Place the probe back into the water.
- Once both calibration stages are complete, the screen will display "Calibration Complete" and return to the main options menu.

# Calibrating the Hanna Probe - pH

 **Important:** When you go into settings the screen will ask if you want to go into HOLD mode.

This will stop the unit from trying to dose. SAY YES

Once you have completed the pH calibration, you can verify the accuracy of your results by following these steps:

## Prepare the Materials:

- A new pH 7.01 sachet
- A beaker of clean (tap) water

## Check pH Calibration:

- Ensure the screen is on the normal running screen which shows readings of pH, ORP and temp.
- Place the probe into the pH 7.01 calibration sachet.
- If the reading is close to 7.01 carry on, if it isn't we can adjust this. \*Note the following buttons need to be pressed fairly quickly otherwise the unit will go into calibration mode.
- MENU
- PH OPTIONS - press left circle under CAL
- Press right circle button under PROCESS
- You can then using up and down arrows adjust level to 7.01
- Press CFM
- Press MENU and go back to main screen, your reading should now be 7.01
- Once done, rinse the sensor in clean water.

# Calibrating the Hanna Probe - ORP

 **Important:** When you go into settings the screen will ask if you want to go into HOLD mode.

This will stop the unit from trying to dose. SAY YES

## Calibrating the ORP Sensor

Make sure you have rinsed the probe first in Clean water

- Scroll to “ORP Set Up” on the screen.
- Press the left blue circle button under “CAL” to begin calibration.
- Open a black 470 mV ORP Test Solution packet and fully submerge the probe in the liquid.
- Use the up and down arrows to adjust the **ORP setting to 470 mV** (matching the packet).
  - Tip: Holding down the arrows will move the mV number faster.
- Transfer the probe into a **second ORP test solution** sachet to ensure any pH solution residue does not interfere.
- Wait for the mV reading to stabilise. **This can take 3–4 minutes**, as ORP calibration takes slightly longer than pH calibration.
- Once the reading stabilises and “CFM” appears in the lower right corner, press “CFM” to confirm.

## Proper Storage or Installation:

- Once calibration is complete, the sensor must either be:
  - Installed in a running system, or
  - Stored correctly by adding storage solution to the sensor cap before fitting it securely.

(ORP can't be checked in the same way as pH - but it can be recalibrated if required)

# Calibrating the Hanna Probe - ORP

 **Important:** When you go into settings the screen will ask if you want to go into HOLD mode.

This will stop the unit from trying to dose. SAY YES

## Re-Fitting the probe - SPA

- Power of the bath - Press the red button on the RCD unit, the bath will now switch off
- Unscrew the silver collar from the Hanna controller (this prevents the cable from twisting).
- Remove the cap that was inserted into the pipework where you removed the probe.
- Carefully screw the probe into the pipework.
- SPA models: Turn the blue taps on either side of the probe so they are inline with the pipe. This means the probe is no longer isolated and water will be able to flow around the filtration system as normal
- Screw the silver collar back on to the Hanna Controller so the probe is now connected to the dosing unit and the bath pipework
- Power on the bath by pressing the orange button on the RCD unit
- The Hanna unit will now switch back on, the screen will show you readings of pH, and mV.  
*If you have - - - lines please see instructions on how to come out of HOLD mode.*

## Re-Fitting the probe -Pro

- Power of the bath - Press the red button on the RCD unit, the bath will now switch off
- Open drain valve to empty the bath.
- Remove the cap that was inserted into the pipework where you removed the probe.
- Carefully screw the probe into the pipework.
- Screw the silver collar back on to the Hanna Controller so the probe is now connected to the dosing unit and the bath pipework
- Open fill valve and fill bath to appropriate level
- Remove the skimmer bung
- Power on the bath by pressing the orange button on the RCD unit
- The Hanna unit will now switch back on, the screen will show you readings of pH, and mV.  
*If you have - - - lines please see instructions on how to come out of HOLD mode.*

# Calibrating the Hanna Probe - Hold Mode

 **Important:** When you go into settings the screen will ask if you want to go into HOLD mode.

This will stop the unit from trying to dose. SAY YES

## HOLD Input Mode

- Press MENU on the Hanna Unit.
- Scroll down General Set Up - Use middle circle to select SET UP
- Scroll down to Hold Input - you will see a tick in the box
- Use the right circle button to select Disable and remove the tick from the box
- Use the left circle button to select ESC.
- You will now see the readings on the display screen

For any further guidance or instructions for your Hanna Doser unit please go to [brassmonkey.co/help](https://brassmonkey.co/help) or contact our support team [brassmonkey.co/support](https://brassmonkey.co/support)

# Settings

 **Important:** When you go into settings the screen will ask if you want to go into HOLD mode.

This will stop the unit from trying to dose. SAY YES

## To check the setting:

- Press MENU on the Hanna Unit.
- **Acid Pump - Auto** (if this is shown as OFF press the circle underneath the word Auto at the bottom of the screen)
- **C12 Pump - Auto** (if this is shown as OFF press the circle underneath the word Auto at the bottom of the screen)
- **pH Options** - Press the circle button under the word SETUP. Go through the pH set up list and check parameters match the table on the next page. Press ESC when complete.
- **ORP Options** - Press the circle button under the word SETUP. Go through the pH set up list and check parameters match the table on the next page. Press ESC when complete.
- **Temperature Options** - Press the circle button under the word SETUP. Go through the temp set up list and check parameters match the table on the next page.
- Once complete go back to Menu
- And ensure Acid pump is on Auto and C12 Pump is on Auto

## Note:

Within the parameters you will notice we disable many of the optional alarms.

We do this because if the Alarm is enabled the unit will stop dosing. It will flash and say warning if there is a problem so checking the Hanna should be a part of the regular testing

# Parameters - Part 1 of 2

| pH Settings  | ORP Settings   |
|--|--|
| Dosing type - Acid   | Set point 740mV  |
| Set point 7.20pH   | Proportional band: 100mV   |
| Proportional band: 1.0pH   | C12 Flow rate - 0.5 L/h  |
| pH Flow rate - 0.5 L/h   | Overtime - 60 minutes  |
| Overtime - 60 minutes  | Alarm high - 900mV   |
| Alarm high - 7.8pH   | Alarm high - Disable (remove the tick in this box)                       |
| Alarm high - Disable (remove the tick in this box)                       | Alarm low - 200mV  |
| Alarm low - 6.8pH  | Alarm Low -Disable (remove the tick in this box)                         |
| Alarm Low -Disable (remove the tick in this box)                         | Warnings and Errors - Enabled (there should be a tick in this box)       |
| Warnings and Errors - Enabled (there should be a tick in this box)       | Alarm activates relay - disable - there should not be a tick in this box |
| Alarm activates relay - disable - there should not be a tick in this box | Alarm mask time - 1minute  |
| Alarm mask time - 5 sec  | Startup dosing delay - 1minute   |
| Startup dosing delay - 1minute   | Analog out - A02   |
| Analog out - A01   | Analog Max - 2000mv  |
| Max Analog out - 14pH  | Analog Min - 0mV   |
| Min Analog out - 2pH   | C12 Tank Input - Disabled  |
| Acid tank Input - disabled   |  |

# Parameters - Part 2 of 2

| Temperature Settings   |
|--|
| Alarm High - 50°C  |
| Alarm high - Disabled (remove the tick in this box)          |
| Alarm Low: 0°C   |
| Alarm Low -Disabled (remove the tick in this box)            |
| Warnings and Errors - Enabled                                |
| Alarm activates relay -Disable (remove the tick in this box) |
| Alarm mask time - 5 sec                                      |
| Unit - Celsius   |
| Analog out - A03   |
| Max Analog out - 105°C                                       |
| Min Analog out - -5°C  |

# Password

## Security Features

The password protection feature protects against unauthorised configuration changes and logged calibration data erasure. Once set, a series of functions cannot be subsequently modified.

This feature is represented by the lock icon displayed on the functional key or on screen title.

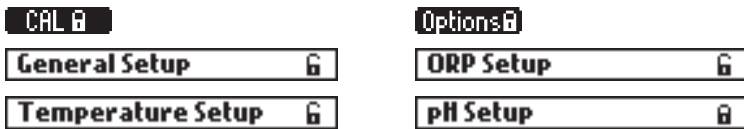

The BL122 & BL123 offer an added password enabled security feature for the remote hold (R\_HOLD) deactivation function (if password protection has been enabled)/

- Select **Controller Password** from the General Setup screen and press **Modify** to activate the feature.



- A five digit password has to be entered next
- To change the digit value, press the up and down arrow keys
- To move to the next digit, press the arrow functional key
- Press **CFM** functiona key to confirm
- To disable the password, select **Controller Password** from the General Setup screen, enter the password and press **CFM** functional key. After the correct password has been entered, press **Disable**.



### Note:

After five failed login attempts, the controller will require a master password. The master password can only be obtained from Hanna Instruments Service. To issue the master password, Hanna Servie will request the use code displayed at the top of the screen.

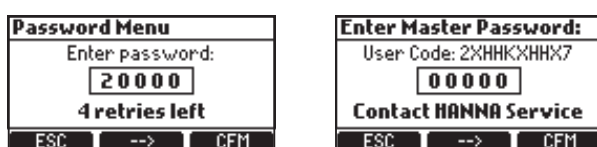

# Section 9: Troubleshooting

## In this section...

- **User Guide for Consumers**
- **Leaks**
- **Power**
- **Fuses**
- **Cloudy Water**
- **Stuck Ice**
- **Light Status**
- **Auto Top Up**
- **Low chlorine levels on opening/top ups**
- **Dosing Lines turning brown/white/blockages**
- **Dosing unit service lights**
- **System Flush**
- **Cleaning Condenser**

# ICE BATHS USER GUIDE

This advice relates to Brass Monkey ice baths operating **10°C or under**

## FIRST, PREPARE YOURSELF

- Shower to clean and prime the surface of your skin prior to entering the water, it's vital to remove oils, lotions and sweat.
- Ensure that you are well-hydrated. Avoid alcohol or heavy meals within the last 90 minutes, failure to do so may increase the risk of hypothermia.
- Never use an ice bath alone. Always ensure another person is present to monitor your wellbeing.
- Deliberate cold exposure asks you to decide to enter, that your mind and body want to.
- Relax: Close your eyes and feel and release any tension, relax your shoulders and jaw - know what you want today from the cold and listen to your body.

## USE THE ICE BATH SAFELY

- The goal is to feel uncomfortable, that you want to get out but feel safe staying in.
- A typical cold water exposure session is to sit and submerge to your neck for 1-3 minutes.
- How much you submerge your body, at what water temperature and for how long are all dependent on how you feel today, this may change daily—listen to your body.
- Keep your head above water at all times, no head dunking.
- Enter the ice bath slowly and carefully to avoid cold shock. Never jump or drop in.
- Limit your immersion to 5 minutes maximum, or until you feel uncomfortably cold, this is typically 2-3 minutes at 0°C-3°C.
- Exit the bath slowly and carefully by first sitting on the back deck. Your limbs may feel stiff at first

## AFTER THE ICE BATH

- After exiting, pat the skin with a towel to dry off and warm up gradually in the warm spa environment.
- Allow the blood flow to return to your limbs and your body to return to normal temperature before repeating the process, if desired.
- Air squats, horse stance, walking or sitting eyes closed are all ways to consciously warm-up.
- Feeling cold after is normal. If you feel any signs of hypothermia (intense shivering, numbness, loss of coordination, confusion), seek medical attention immediately.

### You should not use the ice bath if you:

- Have a serious illness, heart condition, or high blood pressure.
- Are taking medication that affects your body's ability to regulate temperature.
- Have a cold, flu, an open wound, sore, or a skin infection.
- Have Raynaud's syndrome or peripheral neuropathy.
- Have recently eaten a heavy meal (within one hour) or are under the influence of alcohol or drugs.
- Have recently exercised intensely. Allow your body to cool down first.
- Always consult a doctor before engaging in cold water immersion if you have any pre-existing health concerns.

### Be aware that:

- Always shower first to clean and prime the surface of your skin, removing lotions, oils and sweat.
- The water temperature in a Brass Monkey ice bath can be as low as 0°C-10°C (32-50°F). Ice indicates <1°C. Ensure that you can tolerate this temperature.
- Dependent on your tolerance, immersion time should never exceed 5 minutes per session, or 3 minutes for 0°C.
- When using an ice bath, you must allow your body to warm up naturally after each session.
- You must wear appropriate swimwear. Swimwear will not be affected by cold water immersion.
- You should never submerge your head in the ice bath to avoid the increased risk of cold shock, hair products also contaminate the water.

### Potential hazards:

- Adverse reaction to cold or rapid temperature change resulting in dizziness, fainting, or unconsciousness (cold shock response).
- Hypothermia is possible from prolonged exposure to cold water or if you're ill-prepared
- Infection from contamination of the water or ice.
- Slipping injuries caused by wet surrounds or from entry or exit into the ice bath.
- Drowning, especially if experiencing cold shock or cramping.
- Aggravation of existing cardiovascular or respiratory conditions.

### Are you in one of these groups?

**Older Adults:** You may gain some benefits from the use of cold water immersion but should exercise extreme caution due to the stresses on the heart and circulatory system. Older adults should consult with their doctor before attempting cold water immersion.

**Pregnant:** Those who are pregnant are advised not to use ice baths or engage in cold water immersion due to potential risks to the developing fetus. Always seek medical advice before considering cold water therapy during pregnancy.

**Diabetics:** People with diabetes should check with their doctor before using ice baths or cold water immersion. Cold temperatures can affect circulation and nerve sensitivity, potentially exacerbating existing neuropathy issues. Diabetics should also be cautious as the cold may interfere with their ability to detect warning signs of hypoglycemia.

**Cardiovascular Conditions:** Individuals with cardiovascular issues, such as hypertension, heart disease, or circulatory disorders, should avoid ice baths or cold water immersion, as sudden cold exposure can cause a rapid increase in heart rate and blood pressure, potentially leading to adverse cardiac events.

**Respiratory Disorders:** Those with respiratory conditions like asthma or chronic obstructive pulmonary disease (COPD) should exercise caution, as cold water immersion can cause a sudden contraction of the airways, potentially triggering an asthma attack or exacerbating breathing difficulties.

**Experiencing High Levels of Stress:** Take it slowly and be mindful, consider cold showers instead of immersion and talk to your GP. It's essential to approach ice baths cautiously and consider individual factors before deciding if it's appropriate for you to take an ice bath. If you decide, stay above 5°C for gentle and short immersions.

**Children:** The body temperature of young children will drop much quicker than that of older children or adults owing to their underdeveloped thermo-regulatory mechanisms. Children should always be supervised closely by a responsible adult, the amount of time spent in the ice bath should be strictly limited, and they must be warmed up gradually after the session. Adults must be aware of the dangers of hypothermia in children and ensure early indications of stress are not put at risk.

# Leaks

## **If you think you have a leak you need to:**

- Firstly check that all connections are secure and tightened.
- Following this check that the drain valve has been closed correctly and hasn't been left open.
- In warm environments the pipework and exposed parts of pipework can gather condensation. Check if any of the insulation has been damaged and is allowing the build up of condensation.

## **If the unit is leaking you need to:**

- Before draining down the unit try to identify where the leak is coming from, contact our customer support team (photo's / videos of the issue will help us to identify the issue)
- Power off and drain the bath (power off by pressing the Red button on the RCD)

# Loss of Power

## **Power Cuts**

If there is a power cut on the premises, once power returns, reset the bath's RCD by pressing the orange "Reset" button. This should restore power to the bath.

## **No Power to the Bath**

- Can you hear any noise from the bath's components?
- Is anything displayed on the control box or UV?

If no:

- Check that the socket/power source has power.
- Verify that the electrical supply or power source hasn't tripped.
- Try resetting the bath's RCD by pressing the orange "Reset" button inside the compartment.

If still no success, contact the support team, as a fuse may have blown.

# Fuses

## How to identify and address a blown fuse:

Indicators of a blown fuse:

- Mains:
  - No power to the bath.
  - Topside controller is not lit.
  - No noise from any components.
- Pump:
  - No water flow.
  - Test: Place a hand near the water inlets—there should be strong flow. If there's none, it could indicate a blown fuse.
  - Other possible causes: Blue levers not reopened or bath in maintenance mode.
- Compressor:
  - Bath is not cooling.
  - No vibration from the compressor.
  - The support team can confirm via remote tests.
- Solenoid (only applicable to ice generating baths):
  - If you can not enter a defrost mode.
  - The support team can confirm via remote tests.

## Next steps for suspected fuse issues:

- Customers should contact the support team for assistance.
- Opening the PCB has safety risks, and should only be done when it is absolutely necessary under the guidance of the Brass Monkey support team.

# Cloudy Water

**If you can see or believe there is soap/oil in the water or the water looks cloudy:**

- Power down, drain, clean and refill the bath
- Re-fill the bath and complete a back wash to ensure any residues are cleared from within the pipe work and filtration system. The bath will top the water back up
- To reduce this from re-occurring.
  - Ensure clients are showering prior to use.
  - Check maintenance tasks are being completed correctly and as often as required.
  - Check that the testing and dosing of the water is being completed correctly.

## Ice Issues

Not applicable for Chill units

### **Stuck Ice:**

Check for water flow from the bath's inlets:

- Low or no flow:
  - Perform an extended backwash.
  - Ensure blue levers are in the open position.
  - Check for blockages in the pre-filter or drain inside the bath.
- Good flow:
  - Press defrost and repeat until the ice is released.

If the issue persists, contact the support team for further support.

### **Not enough Ice:**

- Lower the temperature to 0°C or increase ice production in the app (set to 1-3).
- Is there morning ice after overnight inactivity?
- If no ice is present at 0°C or 3 ice, contact the support team.

# Light Status

## Standard Operating Status

Applicable to single (chill or Ice) and dual engines :

|   |                  |   |
|---|------------------|---|
| <b>LED ON</b>   | Normal operating | Engine and Pump are on, the unit is either at idle state or cooling to target temperature.  |
| <b>LED flashing</b><br>1 flash - 1 second gap - 1 flash | Maintenance mode | Engine and the pump are off. This is to allow for maintenance tasks to be completed. The unit will stay in this mode until maintenance mode is re-pressed on the control panel. |
| <b>LED flashing</b><br>Quick flash on and off           | Back wash mode   | Engine is off , pump is on.<br>The pump keeps kept on to allow for back washing of filtration.  |

## Chiller Engines Only

|   |                  |   |
|---|------------------|---|
| <b>LED flashing</b><br>1 flash - 5 second gap - 1 flash       | No flow          | Water is unable to flow through the chiller unit.   |
| <b>LED flashing</b><br>3 flashes - 5 second gap - 3 flashes   | Frost protection | The water flowing through bath/barrel is approaching freezing points. Take action to protect your chiller engine. |
| <b>LED flashing</b><br>5 flashes - 5 second gap - 5 flashes   | Overheat         | Your chiller is overheating.<br>Take action to help cool it down.   |
| <b>LED flashing</b><br>10 flashes - 5 second gap - 10 flashes | Lock out         | Your chiller has 'locked - out' to protect itself.  |

# Auto Top-Up

## Not sure if Auto Top Up is working

- Put the bath into maintenance mode (hold the spanner down for 3 seconds)
- Open the drain valve and allow the water to get to the bottom of the skimmer, close the drain valve
- Take the bath out of maintenance mode (hold the spanner down for 3 seconds)
- The auto top up should now start filling the bath so the water line is mid skimmer level.

If this does not happen please contact the Brass Monkey support team

## Auto Top is not maintaining water level correctly

If you have confirmed auto top up is working by following the test above but are finding the water level is dropping below the skimmer unit then there are a couple of possible causes of this

- The drain valve hasn't been fully shut.
  - Open the drain valve and allow the water to get to the bottom of the skimmer, close the drain valve
  - Take the bath out of maintenance mode (hold the spanner down for 3 seconds)
  - The auto top up should now start filling the bath so the water line is mid skimmer level.

If this does not happen please contact the Brass Monkey support team.

# Hanna Dosing Unit

## **No Chlorine on top ups or mornings**

The unit doses in response to the need for sanitisation. If the water is clean (freshly filled or had a period of no use e.g. over night) you may find chlorine levels are below 1ppm. The unit will add chlorine and increase levels once bacteria levels are increased (e.g. when the bath is in use). You can add an ad-hoc dose of chlorine.

## **Dosing Lines Turning Brown**

Dosing lines can turn brown or white over time (they require replacing every 12 months).

This can also happen because when sodium hypochlorite is exposed to air, it begins to calcify. This happens because when sodium hypochlorite is exposed to air, it begins to calcify.

It's important to keep bottles topped up.

If pipework has discoloured please arrange replacements.

## **Status and Service LED's**

If the lights on the dosing unit are either amber or red it is signalling a problem.

Holding the HELP button will confirm what the problem is.

Please refer to the Hanna Manual for further information

## **Adding a Password**

A password can be added to your dosing unit to prevent anyone modifying the calibration settings, ORP / pH set up as well as general settings.

How to do this can be found within the Hanna Instruments Instruction Manual for the BL120 and BL121 controllers.

# Completing a System Flush

## What is a system flush?

A system flush is a product designed to tackle the build up of bio-film, grease and body fats within the system. This is different to a shock dose. A shock dose generally refers to increasing chlorine levels above 10ppm to kill bacteria.

## When would I need to do a system flush?

A system flush maybe suggested if you are experiencing high combined chlorine levels even after ensuring showers before use, correct chemical dosing, and correct water maintenance.

It could also be suggested if the bath has been switched off for a period of time before refilling and opening as during the time switched off bio-film can form within the pipework.

## How do I complete a system flush?

Every product for system flushing will have its own instructions confirming the amount you need to use and how long it needs to be in the system for. Always follow the manufacturers guidance.

## What should I do with my filters when I am doing a system flush?

If you have **cartridge filters** then these will need removing prior to the system flush. Follow instructions for changing the filter to understand how to remove the filters.

If you have a media filter you will need to turn the media filter to circulate to prevent system flush solution from contaminating the media.

For a **manually operated media filter** follow the backwashing guidance but turn the handle to the recirculate position.

For an **automatic media filter valve**, press the ON key and then press TEST and DRAIN at the same time for 4 seconds until the LED of TEST is illuminated. When finished, press OFF and then press the ON button and the filter position will be set to filter again.

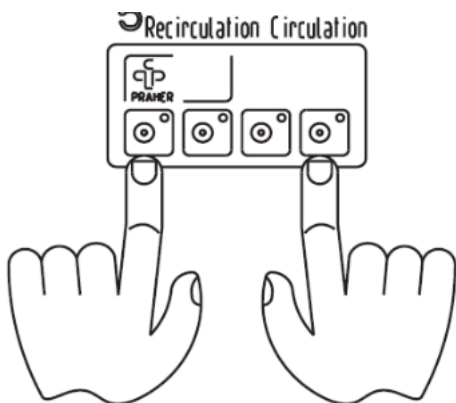

# Cleaning the Condenser

Cleaning the condenser would need to be done Monthly to avoid overheating and unit shutting down

## Spa Range

1. Make sure the unit is switched off before starting.
2. Locate the side panel on the unit.
3. Remove the side panel by carefully popping it off the button fittings.
4. Once the panel is removed, locate the back of the condenser behind the fan.
5. You will see the radiator at the other side of the fan.
6. Using a flue brush, gently clean away any fluff and debris from the back of the radiator.
7. Use a handheld vacuum to remove the loosened dust and debris.
8. Check that the area is clear and there is no remaining build-up.
9. Refit the side panel securely back onto the unit.

## Pro Range

1. Make sure the unit is switched off before starting.
2. Locate the side panel on the unit.
3. Remove the side panel by undoing the nuts and bolts (please refer to the video link provided for guidance on how to do this).
4. Carefully take off the panel and set it aside safely.
5. Once the panel is removed, locate the back of the condenser behind the fan.
6. You will see the radiator on the other side of the fan.
7. Using a flue brush, gently clean away any fluff and debris from the back of the radiator.
8. Use a handheld vacuum to remove the loosened dust and debris.
9. Check that the area is clear and there is no remaining build-up.
10. Refit the side panel and secure it back in place using the nuts and bolts.

## We're in this together!

Need some help? Download the Brass Monkey app or check out our knowledge base at [brassmonkey.co/help](https://brassmonkey.co/help) to troubleshoot most issues. Here's a few tips to keep your plunge in top condition...

- **Keep on top of regular maintenance and cleaning tasks.**

This will prevent most issues ever happening.

- **Regularly monitor the water quality throughout each day.**

Increase the frequency if the user load is high.

- **Keep track of your daily user load.**

We'll need to know this to help with any performance questions.

- **Shower before use.**

You'd be amazed how much sweat, dirty feet and towel fibres impact water quality and filtration flow.

- **Keep your bath connected to wifi.**

That way we can see how it is performing.

- **Make note of the ID number of your plunge(s).**

It is shown beneath the QR code in the compartment area of the plunge.

Call us on +44 1135 267 255

or email [support@brassmonkey.co](mailto:support@brassmonkey.co)

Monday - Thursday 9:00am - 5:30pm

Friday - 9:00am - 4.30pm

Excluding Bank Holidays



Brass Monkey Health Ltd, Thorp Arch Trading Estate Unit 25, Street 6 South  
Wetherby, LS23 7FD